



TOE-S616-11-4

TRANSISTOR INVERTER

# Varispeed-616GII™

380 TO 460V 25 TO 75 HP (18.5 TO 55 kW) 34 TO 82 kVA

## INSTRUCTION MANUAL

Before initial operation  
read these instructions  
thoroughly and retain  
for future reference

When properly installed, operated and maintained, this equipment will provide a lifetime of service. It is mandatory that the person who operates, inspects, or maintains this equipment thoroughly read and understand this manual, before proceeding.

This manual applies to VS-616GII Model CIMR-H18.5G2, -H22G2, -H30G2, -H37G2, -H45G2.

The VS-616GII Drive is an AC variable speed drive system for high-precision variable speed applications. It basically consists of a three-phase squirrel-cage induction motor, a VS-616GII controller (VS-616GII), an operator control station, and optional control units. This manual primarily describes VS-616GII, but contains basic information for operator control station as well. For details of the operation of individual units, refer to their respective manuals.

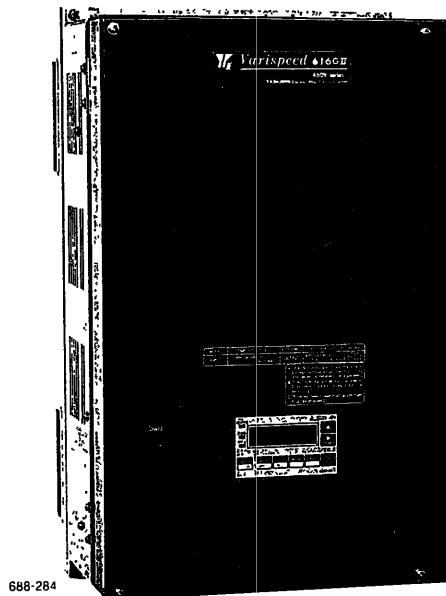

688-284

Type CIMR-H22G2

# CONTENTS

	Page
<b>1. RECEIVING</b> .....	<b>3</b>
<b>2. VS-616GII MAJOR CONTROL COMPONENT LAYOUT</b> .....	<b>4</b>
<b>3. INSTALLATION</b> .....	<b>4</b>
3.1 LOCATION .....	4
3.2 POSITIONING.....	5
3.3 MOUNTING DIMENSIONS .....	5
<b>4. WIRING</b> .....	<b>6</b>
4.1 INTERCONNECTIONS .....	6
4.2 MOLDED-CASE CIRCUIT BREAKER (MCCB) AND POWER SUPPLY MAGNETIC CONTACTOR (MC) .....	8
4.3 SURGE ABSORBER .....	8
4.4 WIRING INSTRUCTIONS .....	9
4.4.1 Control Circuit .....	9
4.4.2 Main Circuit Input/Output .....	9
4.4.3 Grounding.....	10
<b>5. TEST RUN</b> .....	<b>11</b>
5.1 CHECKS BEFORE TEST RUN .....	11
5.2 SIMPLE OPERATION USING DIGITAL OPERATOR .....	11
5.2.1 Set and Operate Frequency Command .....	12
5.2.2 Monitor Function of Digital Operator .....	13
5.3 ADJUSTMENT AND SETTING .....	14
<b>6. OPERATION AT LOAD</b> .....	<b>17</b>
<b>7. MAINTENANCE</b> .....	<b>18</b>
<b>8. FAILURE INDICATION AND DETAILS</b> .....	<b>19</b>
8.1 DISPLAYING THE SEQUENCE OF FAILURE OCCURRENCE .....	20
8.2 STORAGE FUNCTION AT POWER FAILURE .....	21
<b>9. TROUBLESHOOTING</b> .....	<b>22</b>
9.1 TROUBLESHOOTING FOR MOTOR SYMPTOM .....	22
<b>APPENDIX 1 STANDARD SPECIFICATIONS</b> .....	<b>24</b>
<b>APPENDIX 2 TERMINAL FUNCTIONS</b> .....	<b>25</b>
A2-1 Terminals of Main Circuit .....	25
A2-2 Terminals of Control Circuit .....	25
<b>APPENDIX 3 INTERNAL CIRCUIT AND INTERCONNECTION DIAGRAMS</b> .....	<b>28</b>
A3-1 With Braking Unit and Braking Resistor Unit.....	28
A3-2 With Transistor (Open-Collector) For Start / Stop Operation .....	29
<b>APPENDIX 4 SYSTEM CONSTANTS</b> .....	<b>30</b>
A4-1 Inverter Capacity Selection (Sn-10) .....	30
A4-2 Setting of V/f Pattern Selection (Sn-02) .....	31
A4-3 Run Signal Selection (Sn-04) .....	32
A4-4 Protective Characteristics Selection (Sn-05) .....	33
A4-5 Overtorque Detection (Sn-06) .....	34
A4-6 Optional Function Selection (Sn-07) .....	34
A4-7 Terminal Function (Sn-08 to Sn-11) .....	34
A4-8 Contact Output Selection Function (Sn-12) .....	40
<b>APPENDIX 5 CONTROL CONSTANTS</b> .....	<b>42</b>
<b>APPENDIX 6 OTHER CONSTANTS (FUNCTIONS)</b> .....	<b>48</b>
A6-1 Retry Operation Fault .....	48
A6-2 Full Range DC Braking Stop (DB).....	49
A6-3 Range to Prohibit Frequency Setting .....	50
A6-4 Stall Prevention during Operation.....	51
A6-5 Multispeed Setting Method (5-speed operation by internal constants).....	62
<b>APPENDIX 7 OPTION</b> .....	<b>54</b>
<b>APPENDIX 8 CHECK FUNCTION</b> .....	<b>57</b>
<b>APPENDIX 9 CHECKING OF DIODE AND TRANSISTOR MODULES</b> .....	<b>58</b>
<b>APPENDIX 10 WIRE SIZE</b> .....	<b>59</b>
<b>APPENDIX 11 RENEWAL PARTS</b> .....	<b>60</b>

### **DANGER**

- Do not touch circuit components until "CHARGE" lamp is extinguished after turning off the AC main circuit power supply. The capacitors are still charged and can be quite dangerous.
- Do not connect or disconnect wires and connectors while power is applied to the circuit.
- Do not check signals during operation.

### **IMPORTANT**

- Be sure to ground VS-616GII using the ground terminal Ⓒ (Ⓔ). See par. 4.4.3 on page 10.
- Never connect main circuit output terminals Ⓓ (⒰), Ⓔ (⒱), Ⓕ (⒴) to AC main circuit power supply.
- All the potentiometers of VS-616GII have been adjusted at the factory. Do not change their settings unnecessarily.
- Do not make withstand voltage test on any part of the VS-616GII unit, because it is electronic equipment using semi-conductors and vulnerable to high voltage.
- Control PC board employs CMOS IC's which are easily damaged by static electricity. Take care not to touch the CMOS elements inadvertently.

## **1. RECEIVING**

This VS-616GII has been put through demanding tests at the factory before shipment. After unpacking, check for the following.

- Verify the part numbers with the purchase order sheet and/or packing slip.
- Transit damage.

If any part of VS-616GII is damaged or lost, immediately notify the shipper.

## 2. VS-616GII MAJOR CONTROL COMPONENT LAYOUT

VS-616GII major control component is shown in Fig. 1.

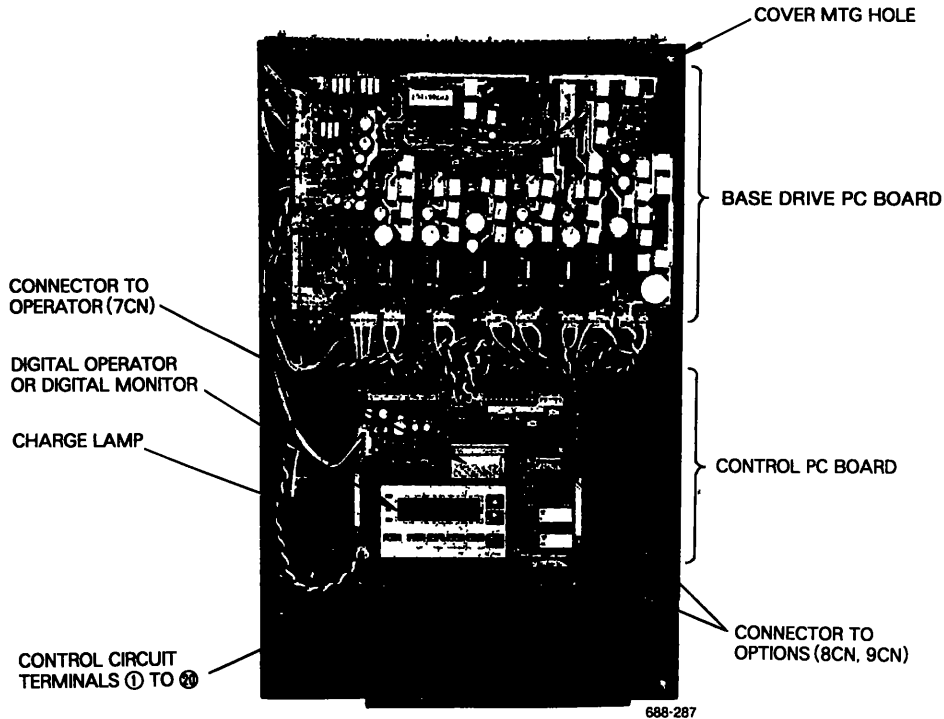

### TERMINAL ARRANGEMENT

⑪	⑫	⑬	⑭	⑮	⑯	⑰	⑱	⑲	⑳											
①	②	③	④	⑤	⑥	⑦	⑧	⑨	⑩											
Ⓒ①	Ⓒ②	Ⓐ①	Ⓐ②	Ⓐ③	Ⓐ④	Ⓐ⑤	Ⓐ⑥	Ⓐ⑦	Ⓐ⑧	Ⓐ⑨	Ⓐ⑩	Ⓐ⑪	Ⓐ⑫	Ⓐ⑬	Ⓐ⑭	Ⓐ⑮	Ⓐ⑯	Ⓐ⑰	Ⓐ⑱	Ⓐ⑳

Fig. 1 Major Control Component Layout of VS-616GII Model CIMR-H22G2 with ETL certification

## 3. INSTALLATION

### 3.1 LOCATION

Location of the equipment is important to achieve proper performance and normal operating life. The VS-616GII units should be installed in areas where the following conditions exist.

- Ambient temperature: -10 to +40° C (For enclosed type),  
-10 to +50° C (For open chassis type)
- Protected from rain or moisture.
- Protected from direct sunlight.
- Protected from corrosive gases or liquids.
- Free from airborne dust or metallic particles.
- Free from vibration.

### 3.2 POSITIONING

For cooling and maintenance purposes, make sure that there is sufficient clearance around the equipment, as shown in Fig. 2.

To keep effective cooling conditions, it must be installed vertically to the ground using the four mounting screws.

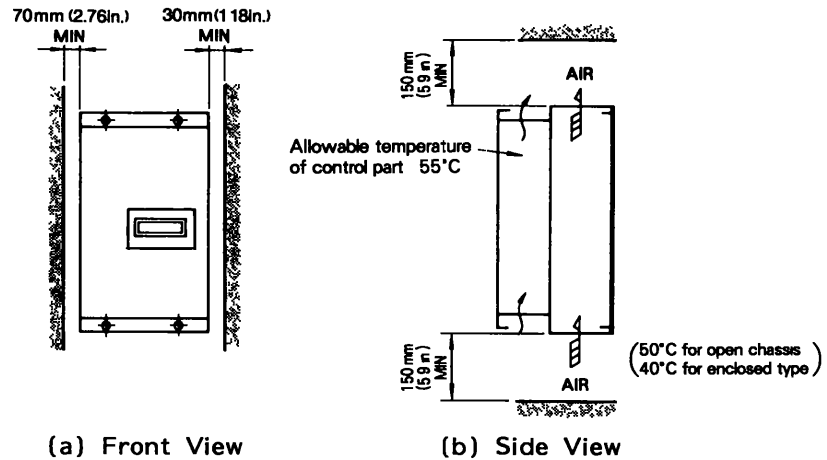

Fig. 2 VS-616GII Clearance Requirements for Proper Cooling and Maintenance

### 3.3 MOUNTING DIMENSIONS

The mounting dimensions for the VS-616GII are given in Fig. 3. and Table 1.

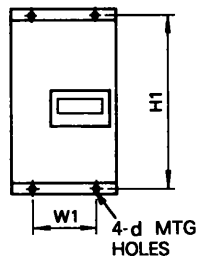

Fig. 3 Cabinet Mounting Holes

Table 1 Cabinet Mounting Dimensions

Model		380 to 460 V				
		CIMR-H1 8.5 G2	CIMR-H22 G2	CIMR-H30 G2	CIMR-H37 G2	CIMR-H45 G2
Dimensions		Dimensions in mm (inch)				
W1	Open Chassis Type	265 (10.43)			250 (9.84)	
	Enclosed Type (NEMA 1)	445 (17.52)			465 (18.31)	
H1	Open Chassis Type	535 (21.06)			705 (27.76)	
	Enclosed Type (NEMA 1)	600 (23.62)			775 (30.51)	
d	Open Chassis Type	M6			M8	
	Enclosed Type (NEMA 1)	M8			M8	

# 4. WIRING

## 4.1 INTERCONNECTIONS

Fig. 4 shows the connection diagram for combination of VS-616GII with only digital operator. Remove the front cover before wiring. Connections should be made correctly, referring to Fig. 4.

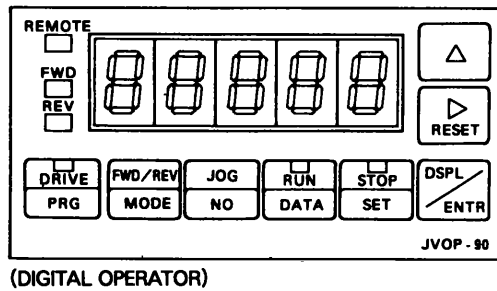
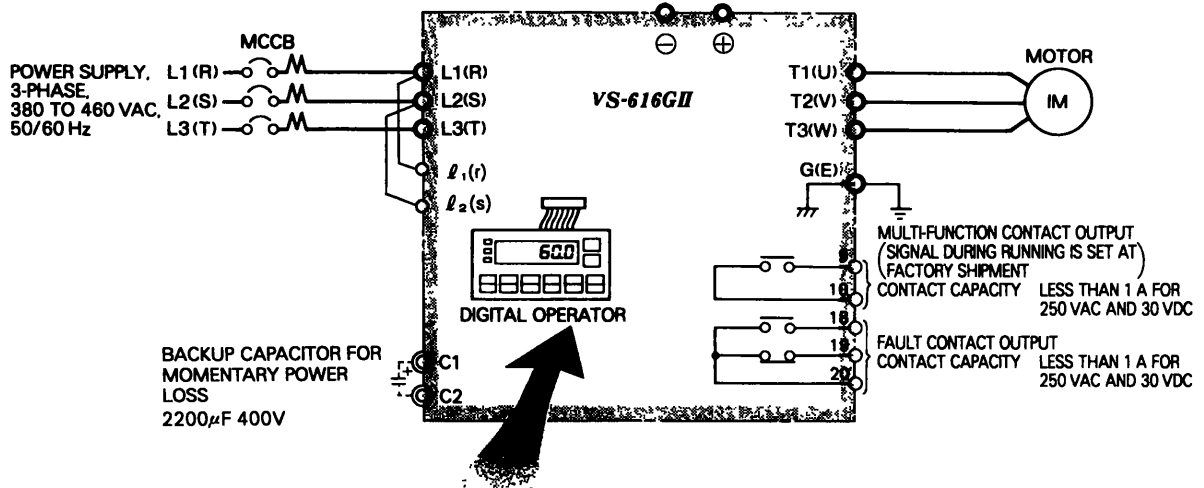

Note: Terminal symbol:  $\odot$  shows main circuit; and  $\circ$  shows control circuit.

Fig.4 Example of Interconnections for Operation with Digital Operator

Fig. 5 shows the connection diagram of VS-616GII for operation by external signals.

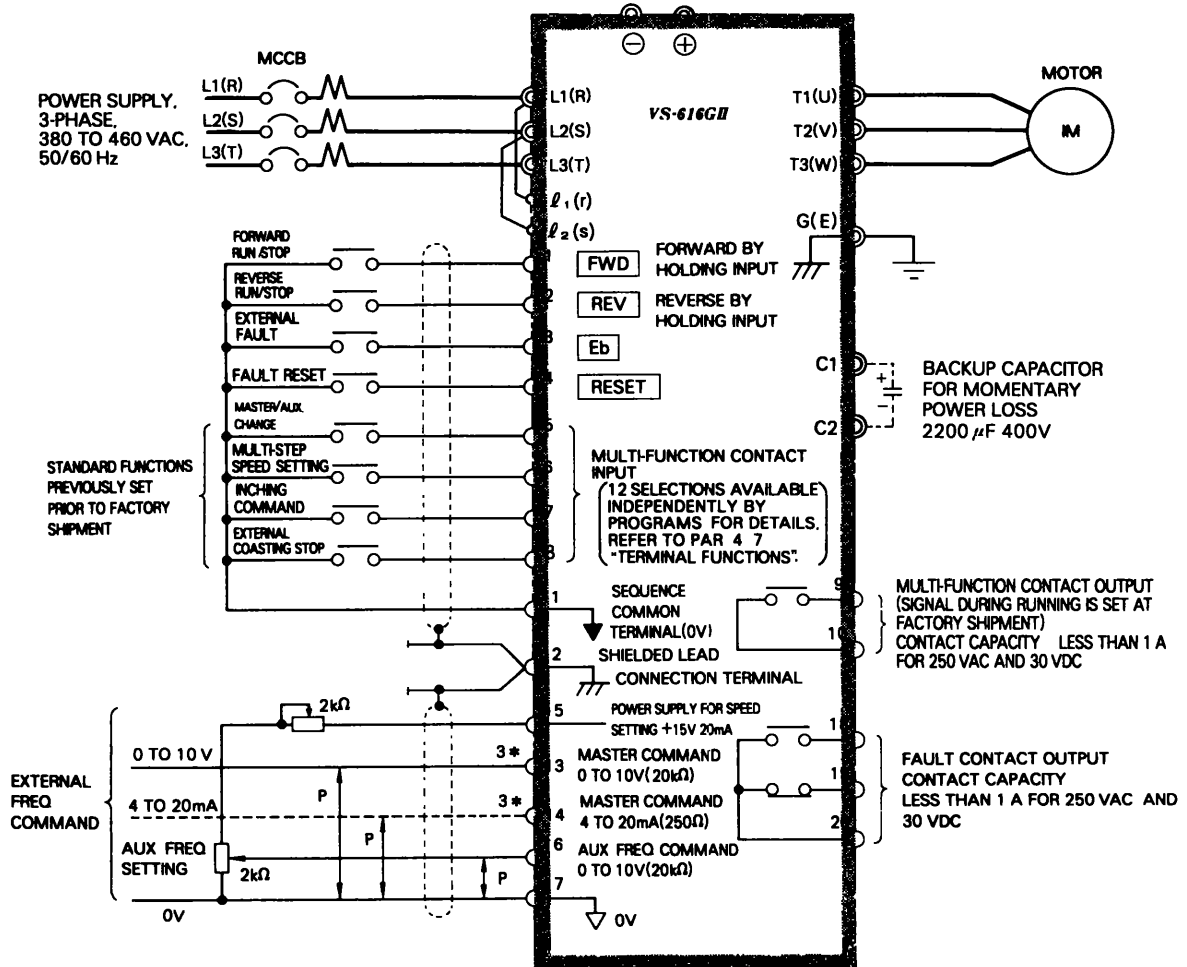



Fig. 5 Example of Interconnections for Operation by External Signals

Notes:

1.  indicates shielded leads and  twisted-pair shielded leads.
2. External terminal ⑮ of +15V has maximum output current capacity of 20mA.
3. Either external terminal ⑬ or ⑭ can be used.
4. Terminal symbols: ● shows main circuit; ○ shows control circuit.
5. Use high reliable control relay for switching input command. Contact voltage and current; 24V. 18mA (typical values)

## 4.2 MOLDED-CASE CIRCUIT BREAKER (MCCB) AND POWER SUPPLY MAGNETIC CONTACTOR (MC)

Be sure to connect MCCBs between power supply and VS-616GII input terminals  $\text{L1 (R)}$ ,  $\text{L2 (S)}$ ,  $\text{L3 (T)}$ . Recommended MCCBs are listed in Table 2.

When a ground fault interrupter is used to prevent malfunction, setting current should be 200mA or over and operating time, 0.1 sec or over.

Table 2 Molded-Case Circuit Breakers and Magnetic Contactors

VS-616GII	Model CIMR-	H18.5G2	H22G2	H30G2	H37G2	H45G2
	Capacity kVA	34	41	54	68	82
	Rated Output Current A	45	54	72	90	108
Mitsubishi Molded-Case Circuit Breaker	Model and Rated Current*	NF100 100A	NF100 100A	NF100 100A	NF225 150A	NF225 150A
Yaskawa Magnetic Contactors Model		HI-50E	HI-50E	HI-80E	HI-100E	HI-100E

\*Comply with NEMA AB1.

## 4.3 SURGE ABSORBER

For the surge absorbers to be connected to the coils of relays, magnetic contactors, magnetic valves, or magnetic relays, select types from the ones listed in Table 3.

Table 3 Surge Absorbers

Coils of Magnetic Contactor and Control Relay	Surge Absorber*		
	Model	Specifications	Code No.
Large-size Magnetic Contactors	DCR2-50A22E	250 VAC $0.5 \mu\text{F} + 200 \Omega$	C002417
Control Relay LY-2, -3 (OMRON) HH-22, -23 (Fuji) MM-2, -4 (OMRON)	DCR2-10A25C	250 VAC $0.1 \mu\text{F} + 100 \Omega$	C002482

\*Made by MARCON Electronics.

### IMPORTANT

Lead size should be determined considering voltage drop of leads. Refer to APPENDIX 10 "WIRE SIZE".



## 4.4 WIRING INSTRUCTIONS

### 4.4.1 Control Circuit

The external interconnection wiring must be performed with following procedures.

After completing VS-616GII interconnections, be sure to check that connections are correct. Never use control circuit buzzer check.

#### (1) Separation of control circuit leads and main circuit leads

Signal leads ① through ⑳ must be separated from main circuit leads ① (R), ② (S), ③ (T),  $\ominus$   $\oplus$ , ④ (U), ⑤ (V), ⑥ (W), ⑦ (r), ⑧ (s), ⑨ C1, ⑩ C2, and another power cables to prevent erroneous operation caused by noise interference.

#### (2) Control circuit leads ⑨ ⑩ ⑱ ⑲ ⑳ (contact output) must be separated from leads ① to ⑧ and ⑪ to ⑰.

Use the twisted shielded or twisted-pair shielded lead for the control circuit line and connect the shield sheath to the inverter terminal ⑫. See Fig. 6.

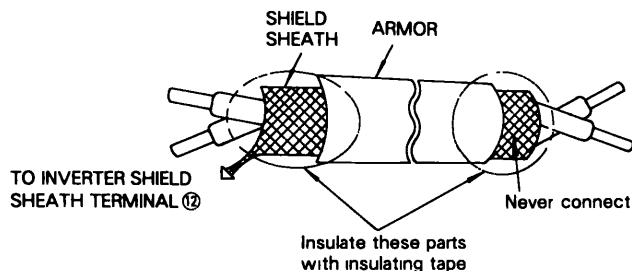

Fig. 6 Shielded Lead Termination

#### (3) Wiring distance

It is recommended that the wiring distance of the signal leads (① - ⑳) be 50 meters (164 feet) or below.

### 4.4.2 Main Circuit Input/Output

#### (1) Direction of phase rotation of power

- Phase rotation of power is available in either direction, clockwise and counterclockwise.
- When inverter output terminals ④ (U), ⑤ (V), and ⑥ (W) are connected to motor terminals ④ (U), ⑤ (V), and ⑥ (W), respectively, motor rotates counterclockwise, viewed from opposite drive end, upon forward operation command. To reverse the rotation interchange any two of motor leads.

#### (2) Never connect AC main circuit power supply to output terminals ④ (U), ⑤ (V), and ⑥ (W).

(3) Care should be taken to prevent contact of wiring leads with VS-616GII cabinet, for short-circuit may result.

(4) Never connect power factor correction capacitor or noise filter to VS-616GII output.

(5) For the operation to feed DC power supply from terminals  $\oplus$  and  $\ominus$ , be sure to remove the leads ① (R) ⑦ (r) and ② (S) ⑧ (s), then connect the cooling fan or MC power supply (380 to 460V, 50/60Hz) to ⑦ (r) or ⑧ (s) terminal.

### 4.4.3 Grounding

Make a positive grounding using ground terminal (G) (E) on the casing of VS-616GII.

- (1) Ground resistance should be  $100\ \Omega$  or less.
- (2) Never ground VS-616GII in common with welding machines, motors, and other large-current electrical equipment, or ground pole. Run the ground lead in a separate conduit from leads for large-current electrical equipment.
- (3) Use ground lead listed in Table 18 (page 47) and make the length as short as possible.
- (4) Where several VS-616GII units are used side by side, all the units should preferably be grounded directly to the ground poles. However, connecting all the ground terminals of VS-616GII in parallel, and ground only one of VS-616GII to the ground pole is also permissible (Fig. 7). However, do not form a loop with the ground leads.

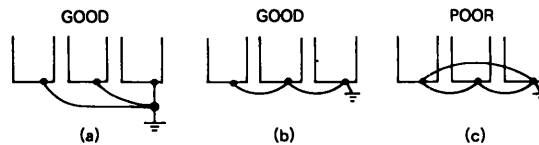

Fig. 7 Grounding of Three VS-616GII Units

# 5. TEST RUN

## 5.1 CHECKS BEFORE TEST RUN

After mounting and connection are completed, check for:

- Correct connections
- Short-circuit conditions
- Loose screw terminals  
(Check especially for loose wire clippings.)
- Proper load condition
- Proper power voltage selection

Select the proper position by AC main circuit power voltage value as shown in right figure, and set the connector to it. The voltage is preset to the position of 460V prior to factory shipment.

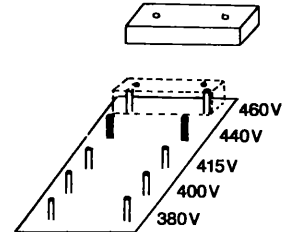

POWER VOLTAGE SELECTION

## 5.2 SIMPLE OPERATION USING DIGITAL OPERATOR

The following description is for the operation of a standard motor running at 60Hz.

Wire according to Fig. 4 "Sample of Mutual Wiring" (operation using the digital operator).

Data set with the digital operator is stored after the power is turned off.

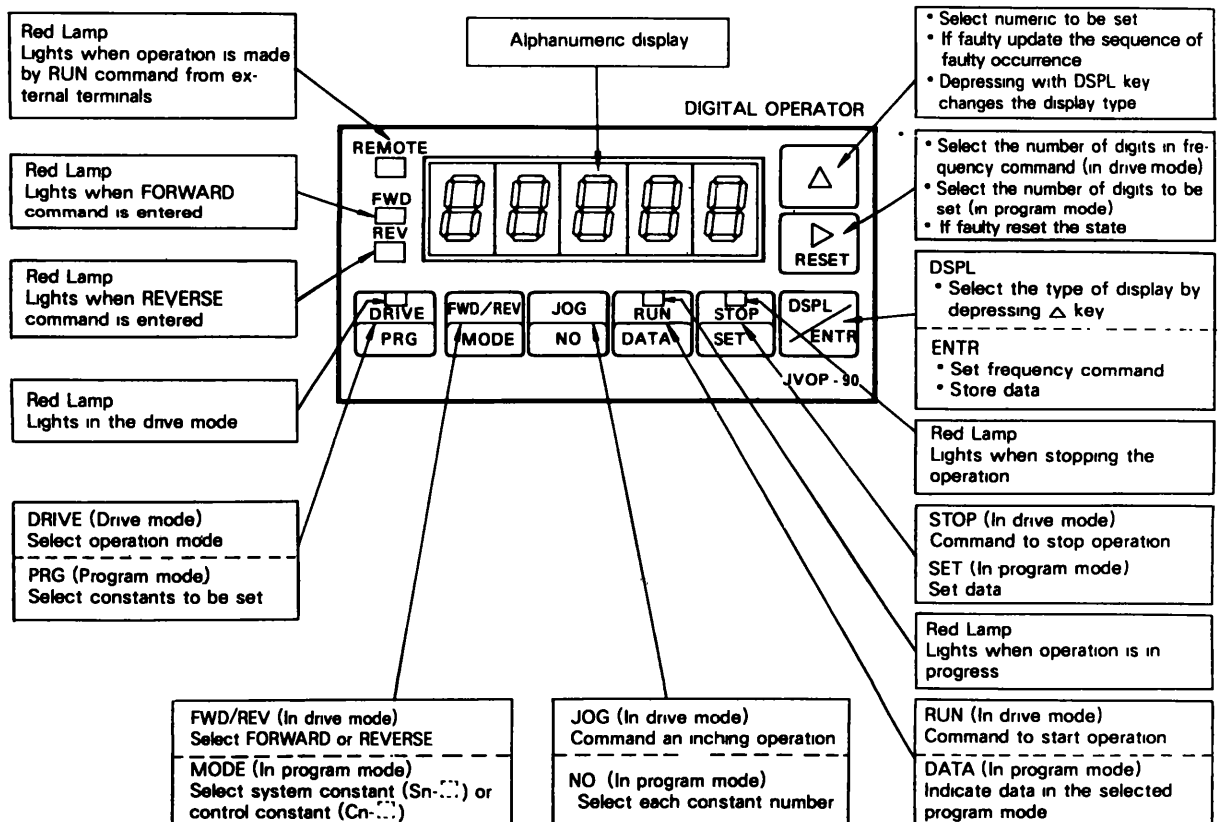





Fig. 8 Functions of digital operator keys





### 5.2.1 Set and Operate Frequency Command

Set frequency command in drive mode (  ).

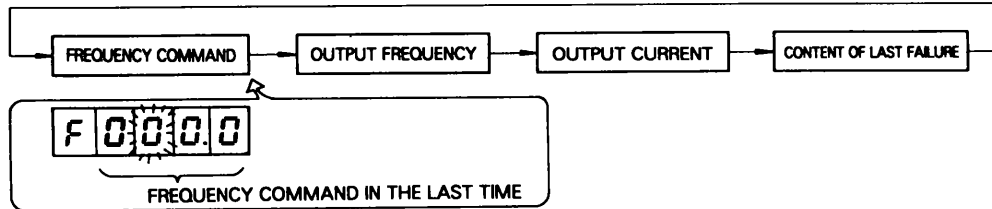

Setting:

- (1) Depress  while depressing  ; then the frequency command appears. When this is repeated, the display changes as follows. See (3) for details.



- (2) Using  flash can be moved to the digit to be set, and the numeric set with  key.
- (3) Depress  to store the frequency command value.  
(Stored data is maintained when the power is off.)
- (4) Depress  while depressing  to select the output frequency to be indicated.

Operation

- (5) Depress  to select the motor rotating direction.
- (6) Depress  to give run command. The motor accelerates according to the specified acceleration time (10 s) and holds the speed at the specified frequency.

Stop operation

- (7) Depress  to stop the motor. The motor decelerates according to the specified deceleration time (10 s).

## 5.2.2 Monitor Function of Digital Operator

### (a) Output frequency display

The output frequency appears in units of 0.1 Hz.

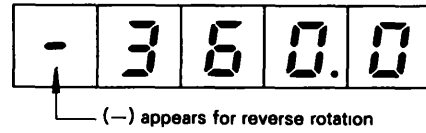

### (b) Frequency command display

The following display appears in units of 0.1Hz, depending on the operation performed with the frequency command either from the external terminal or digital operator.

#### (1) Operation by frequency command from the external terminal

The frequency command specified from the external terminal appears.

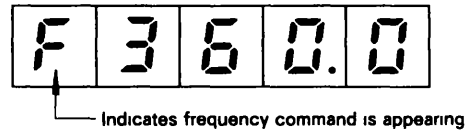

#### (2) Operation by frequency command from the digital operator.

The frequency command specified from the digital operator appears. The digit which is flashing can be changed. A frequency command can also be set.

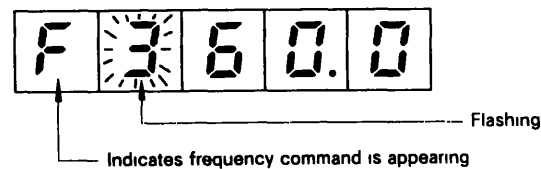

### (c) Output current display

The inverter output current appears in units of 0.1 A.

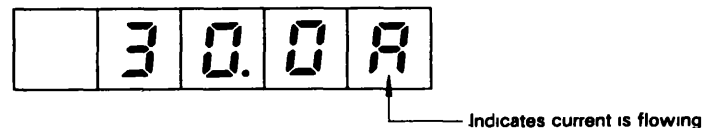

### 5.3 ADJUSTMENT AND SETTING

The VS-616GII has the following two constants to select the function and change the characteristics. Before starting operation, set these constants to meet the operation condition.

- System constants (Sn-01 to Sn-12): Mainly used to select V/f and the function of external terminals (Table 4).
- Control constants (Cn-01 to Cn-30): Mainly used to change characteristics (Table 5).

Table 4 System Constants(Sn-□)

System Constant No.	Name	Function	Setting Value at Factory Shipment																		
Sn-01	kVA selection	Sets printed circuit board constants commonly used for multiple inverters	Already set (Spare part needs new setting)																		
02	V/f pattern selection	16 V/f patterns are available for use so that the operation suited to the motor type load characteristics, and operation condition can be performed 15 types V/f pattern is selectable by setting 0 to E (See page 29) 1 type V/f pattern can be changed by setting F																			
03			0000																		
04	Operation signal selection	<table border="1"> <tr> <td>Data</td> <td>0</td> <td>1</td> </tr> <tr> <td>Digit</td> <td></td> <td></td> </tr> <tr> <td>1st</td> <td>Controlled by Frequency command from the external terminal</td> <td>Controlled by Frequency command from the digital operator</td> </tr> <tr> <td>2nd</td> <td>Controlled by Run command from the external terminal</td> <td>Controlled by Run command from the digital operator</td> </tr> <tr> <td>3rd</td> <td>Main speed frequency command 0-10V/0-100% 4-20mA/0-100%</td> <td>Main speed frequency command 0-10V/100-0% 4-20mA/100-0%</td> </tr> <tr> <td>4th</td> <td>Reverse allowed</td> <td>No reverse allowed</td> </tr> </table>	Data	0	1	Digit			1st	Controlled by Frequency command from the external terminal	Controlled by Frequency command from the digital operator	2nd	Controlled by Run command from the external terminal	Controlled by Run command from the digital operator	3rd	Main speed frequency command 0-10V/0-100% 4-20mA/0-100%	Main speed frequency command 0-10V/100-0% 4-20mA/100-0%	4th	Reverse allowed	No reverse allowed	 (Controlled by digital operator)
		Data	0	1																	
		Digit																			
		1st	Controlled by Frequency command from the external terminal	Controlled by Frequency command from the digital operator																	
2nd	Controlled by Run command from the external terminal	Controlled by Run command from the digital operator																			
3rd	Main speed frequency command 0-10V/0-100% 4-20mA/0-100%	Main speed frequency command 0-10V/100-0% 4-20mA/100-0%																			
4th	Reverse allowed	No reverse allowed																			
05	Protection characteristics selection	<table border="1"> <tr> <td>1st</td> <td>Operation stops at a momentary power failure</td> <td>Operation continues at a momentary power failure</td> </tr> <tr> <td>2nd</td> <td>Operation stalls during deceleration</td> <td>Operation will not stall during deceleration</td> </tr> <tr> <td>3rd</td> <td>The electronic thermal motor protected</td> <td>The electronic thermal motor not protected</td> </tr> <tr> <td>4th</td> <td>The electronic thermal protector (reduced torque)</td> <td>The electronic thermal protector (constant torque)</td> </tr> </table>	1st	Operation stops at a momentary power failure	Operation continues at a momentary power failure	2nd	Operation stalls during deceleration	Operation will not stall during deceleration	3rd	The electronic thermal motor protected	The electronic thermal motor not protected	4th	The electronic thermal protector (reduced torque)	The electronic thermal protector (constant torque)	0000						
1st	Operation stops at a momentary power failure	Operation continues at a momentary power failure																			
2nd	Operation stalls during deceleration	Operation will not stall during deceleration																			
3rd	The electronic thermal motor protected	The electronic thermal motor not protected																			
4th	The electronic thermal protector (reduced torque)	The electronic thermal protector (constant torque)																			
06	Overtorque detection	<table border="1"> <tr> <td>1st</td> <td>Overtorque not detected</td> <td>Overtorque detected</td> </tr> <tr> <td>2nd</td> <td>Overtorque detected during speed synchronization</td> <td>Overtorque always detected</td> </tr> <tr> <td>3rd</td> <td>Operation continues</td> <td>Coasting stop</td> </tr> <tr> <td>4th</td> <td></td> <td></td> </tr> </table>	1st	Overtorque not detected	Overtorque detected	2nd	Overtorque detected during speed synchronization	Overtorque always detected	3rd	Operation continues	Coasting stop	4th			0000						
1st	Overtorque not detected	Overtorque detected																			
2nd	Overtorque detected during speed synchronization	Overtorque always detected																			
3rd	Operation continues	Coasting stop																			
4th																					
07	Optional function selection	<table border="1"> <tr> <td>1st</td> <td rowspan="2">Used when the pulse monitor (model JOGB-C01) is installed</td> </tr> <tr> <td>2nd</td> </tr> <tr> <td>3rd</td> <td rowspan="2">Used when the input interface (model JOGB-C04) is installed</td> </tr> <tr> <td>4th</td> </tr> </table>	1st	Used when the pulse monitor (model JOGB-C01) is installed	2nd	3rd	Used when the input interface (model JOGB-C04) is installed	4th	0000												
1st	Used when the pulse monitor (model JOGB-C01) is installed																				
2nd																					
3rd	Used when the input interface (model JOGB-C04) is installed																				
4th																					
08	External terminal ⑤	Select terminal 5 function in accordance with table 15 (Page 35)	0																		
09	External terminal ⑥	Select terminal 6 function in accordance with table 15 (Page 35)	3																		
10	External terminal ⑦	Select terminal 7 function in accordance with table 15 (Page 35)	5																		
11	External terminal ⑧	Select terminal 8 function in accordance with table 15 (Page 35)	6																		
12	Contact output ⑨, ⑩	Select contact output function in accordance with table 17 (Page 40)	0																		
13	Output interface (model JOGB-C03) (Open collector output)	Terminal ①	Select terminal ① function of the output interface in accordance with table 17 (Page 40)	0																	
14		Terminal ②	Select terminal ② function of the output interface in accordance with table 17 (Page 40)	0																	
15		Terminal ③	Select terminal ③ function of the output interface in accordance with table 17 (Page 40)	0																	
16		Terminal ④	Select terminal ④ function of the output interface in accordance with table 17 (Page 40)	0																	

Table 5 Control Constants (Cn-01)







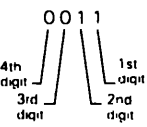

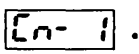

Control Constant No.	Name	Unit	Setting Range	Setting Value Prior to Factory Shipment
Cn-01	Max Frequency (F MAX)	0.1 Hz	50.0 – 400.0 Hz	60 Hz
02	Max Voltage (V MAX)	0.1 V	0.0 – 460.0 V	400 V
03	Max Voltage Freq (F A)	0.1 Hz	0.0 – 400.0 Hz	60 Hz
04	V/f Constant (F B)	0.1 Hz	0.0 – 400.0 Hz	3 Hz
05	V/f Constant (V c)	0.1 V	0.0 – 460.0 V	26 V
06	Min Output Freq (F MIN)	0.1 Hz	0.0 – 400.0 Hz	1.5 Hz
07	Min Output Freq Voltage (V MIN)	0.1 V	0.0 – 460.0 V	14 V
08	Accel Time	0.1 s	0.1 – 1800.0 s	10.0 s
09	Decel Time	0.1 s	0.1 – 1800.0 s	10.0 s
10	DC Injection Braking Voltage	0.1 V	0.0 – 200.0 V	15 V
11	DC Injection Braking Time at stop	0.1 s	0.0 – 100.0 s	0.5 s
12	DC Injection Braking Time at start	0.1 s	0.0 – 25.5 s	0.0 s
13	Freq Command Gain	0.01	0.01 – 2.55	1.00
14	Freq Command Bias	0.1 %	0.0 – 25.5 %	0.0
15	Freq Command Upper Limit	1 %	0 – 110 %	100 %
16	Freq Command Lower Limit	1 %	0 – 110 %	0 %
17	Setting Prohibited Freq 1	0.1 Hz	0.0 – 400.0 Hz	0.0 Hz
18	Setting Prohibited Freq 2	0.1 Hz	0.0 – 400.0 Hz	0.0 Hz
19	Setting Prohibited Freq 3	0.1 Hz	0.0 – 400.0 Hz	0.0 Hz
20	Motor Rated Current	0.1 A	0.1 – 360.0 A	See Table 12.
21	Carrier Freq Lower	1 Hz	380 – 2500 Hz	380 Hz
22	Torque Compensation Gain	0.1	0.0 – 9.9	1.0
23	Over Torque Detecting Level	1 %	30 – 200 %	160 %
24	Freq Monitor Gain	0.01	0.01 – 2.00	1.00
25	Current Monitor Gain	0.01	0.01 – 2.00	1.00
26	Inching Freq	0.1 Hz	0.0 – 400.0 Hz	6.0 Hz
27	Freq. Command 1 for Multi-step Run	0.1 Hz	0.0 – 400.0 Hz	0.0 Hz
28	Freq Command 2 for Multi-step Run	0.1 Hz	0.0 – 400.0 Hz	0.0 Hz
29	Accel/Decel Time	0.1 s	0.1 – 1800.0 s	10.0 s
30	Save Energy Gain	1 %	0 – 120 %	80 %
31	Slip Compensation Gain	0.1	0.0 – 9.9	0.0
32	Speed Display (Freq, RPM, Speed %, etc)	1	0 – 39999	0
33	Optional Speed Agreed Frequency	0.1 Hz	0.0 – 400.0 Hz	0.0 Hz

### 5.3 ADJUSTMENT AND SETTING (Cont'd)



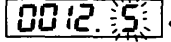

[Example: Adjusting acceleration and deceleration time]



An example to set the acceleration/deceleration time using control constants 8 and 9 (Cn-08 and Cn-09) is described below. This must be carried out while the inverter is not running.

Setting acceleration time:

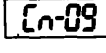
- (1) Depress  to select the program mode. ( Light off)
- (2) Depress  to select control constnt .
- (3) Using , move the flashing digit, select the numeric with  and indicate  (control constant 8).
- (4) Depress  to indicate the internal data of control constant 8.
- (5) Set the required acceleration time by operating  and . The time can be set up to 1800 seconds at 0.1 second intervals.  
(When 12.5 seconds is set, it appears .)
- (6) Depress  to temporarily store data.

Setting deceleration time:

- (7) Depress  to indicate  again.
- (8) Depress  to indicate  (control constant 9).
- (9) Operate the same as setting of acceleration time, and depress  to store data.

After setting, depress [  ] to resume the drive mode. ( Light on.)



## 6. OPERATION AT LOAD

After the no-load operation, turn off the AC main circuit power, and connect the driven machine to the motor. Make sure that the driven machine is in running condition, and that proper safety precaution are followed, then run the motor under load in exactly the same way as the test run.

For preset starting (one-touch operation after setting the frequency) Perform the following beforehand:

(1) Set the frequency and depress 

RUN
DATA

 to accelerate the motor in the determined time, as described earlier, and to maintain the rpm at the preset frequency. If the acceleration time is set short relative to the load and if the rpm of the accelerating motor is not smooth (anti-stalling function during acceleration is functioning); or if trouble is displayed on the digital operator, set the acceleration time longer.

(2) To decelerate the motor in the preset time and to stop it, depress 

STOP
SET

 while the motor is rotating. If the deceleration time is set short relative to the load and if the rpm of the decelerating motor is not smooth (anti-stalling function during deceleration is functioning); or if trouble is displayed on the digital operator, set the deceleration time longer.

### PRECAUTION

- (1) Start the motor after making sure that the motor is stopped. If the operation is started during motor coasting, use the control constant (Cn-12) DC Injection Braking Time at start in table 5.
- (2) When a standard motor is driven with the inverter, there is a little increase in motor temperature, noise, and vibration as compared to the operation from the commercial power supply.
- (3) The motor cooling effect lowers during low-speed running. The torque needs to be reduced in accordance with the frequency. (For the reduction ratio, refer to the catalog or technical sheet.)
- (4) Even with small load, never use a motor whose current exceeds the inverter rating.
- (5) When two or more motors are operated, check to be sure that the total motor current is not larger than inverter rating.
- (6) When starting and stopping the motor, be sure to use the operation signals (FWD/REV), not the magnetic contactor on the power supply side.

## 7. MAINTENANCE

VS-616GII requires almost no routine checks. It will function efficiently and longer if it is kept clean, cool and dry, observing precautions listed in 3.1 Location, on page 4. Especially check for tightness of electrical connections, discoloration or other signs of overheating. Use Table 6 as the inspection guide. Before servicing inspection, turn off AC main circuit power and be sure that CHARGE lamp is off.

Table 6 Periodical Inspection

Component	Check	Corrective Action	Inspection Period
External terminals, unit mounting bolts, connectors, etc.	Loosened screws	Tighten	Once / Year
	Loosened connectors	Tighten	
Cooling fins	Build-up of dust and dirt	Blow with a dry compressed air of 4 to 6 kg·cm <sup>2</sup> (57 to 85 lbs·in <sup>2</sup> ) pressure	
Printed circuit board	Accumulation of conductive dust and oil mist	Clean the board. If dust and oil cannot be removed, replace the board.	
	Discoloration to brown	Replace the board.	
Cooling fan	For abnormal noise and vibration. Whether the cumulative operation time exceeds 20,000 hours or not.	Replace the cooling fan	
Power elements	Accumulation of dust and dirt	Blow with a dry compressed air of 4 to 6 kg·cm <sup>2</sup> (57 to 85 lbs·in <sup>2</sup> ) pressure.	Once / Year
Smoothing capacitor	Discoloration or odor	Replace the capacitor or inverter unit.	

## 8. FAILURE INDICATION AND DETAILS

As Table 7 shows, the failure that the VS-616GII detects is classified into trouble and alarm. When trouble occurs, the failure contact is output and the operation stops after coasting. When an alarm is issued, the digital operator indicates the alarm for warning. (An alarm is not stored in the inverter.)

Table 7 Failure Indication and Details

Indication	Failure Indication Item	Description	Failure Classification
UU Blink	A low voltage being detected	Two seconds are being counted after the detection of low voltage	Alarm
OU Blink	Overvoltage during stop	The DC voltage is higher than the specified value	Alarm
OH2 Blink	Inverter overheat is predicted	An overheat signal is entered from the external terminal	Alarm
OL3 Blink	Overtorque being detected	Operation continues despite over-torque	Alarm
Eb Blink	Both forward run and reverse run commands are closed	Deceleration stop (Not stored internally)	Alarm
UU	Low voltage	The DC voltage is lower than the specified value	Trouble
FU	Fuse blown	The main circuit fuse is blown	Trouble
OC	Overcurrent	A current surge of about 200% or more occurs	Trouble
OU	Overvoltage	The DC voltage is higher than the specified value	Trouble
OH	The radiation fin overheated	The thermo-switch for the radiation fin operates	Trouble
OL 1	Overload	Protect the motor	Trouble
OL 2	Overload	Protect the inverter	Trouble
OL 3	Overtorque	Overtorque causes the operation to stop after coasting.	Trouble
Eb	External failure	An external failure signal stops operation	Trouble
CPF	Control function self-diagnosis function is faulty.	When DSPL/ENTR key is depressed, CPF content appears	Trouble
OPE	Illegal constant is set	Constant logic is not coincident	Trouble
• • • • •	Control function hardware is faulty.	Watchdog error	Trouble

## 8.1 DISPLAYING THE SEQUENCE OF FAILURE OCCURRENCE

Failure items that currently occur and that occurred before the power was turned off can be sequentially indicated by the following procedure:

(1) To indicate the sequence of failure items that currently occur

When  is depressed, the sequence of trouble occurrence appears (up to four faults), except for OPE (illegal constant setting) and control function hardware fault.

[Example of Indication]

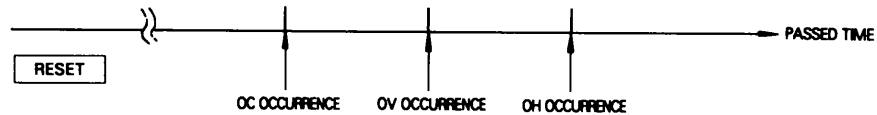

- |                                    |      |                                    |                     |
|------------------------------------|------|------------------------------------|---------------------|
| ① First indication                 | OC   | ④ Depress <input type="checkbox"/> | 3 OH                |
| ② Depress <input type="checkbox"/> | 1 OC | ⑤ Depress <input type="checkbox"/> | 1 OC                |
| ③ Depress <input type="checkbox"/> | 2 OV |                                    | Returns to ② state. |

(2) To indicate the sequence of failure items that occurred before the power was turned off

The VS-616GII uses NV-RAM to store the sequence of failure items that occurred before the power was turned off (when low voltage is detected). Therefore, when the power is turned on again, the sequence of such failure items (up to four) appears on the digital operator display.

[Example of Indication]



After the power is turned on:

- 1) The first failure item that occurred before the power was turned off appears: U1 OC .... Blinks 5 seconds
- 2) The first display:  [The type of display selected before turning off the power]
- 3) Depress  +  to display the sequence of failure occurrence: U1 OC
- 4) Depress  : U2 OH
- 5) Depress  : U1 OC Returns to 2)
- 6) Return to the display type selected before depressing  +  to display the sequence of failure occurrence:

Note: If no failure item occurred before the power was turned off, U1-- appears in step 3).

## **8.2 STORAGE FUNCTION AT POWER FAILURE**

The VS-616GII uses the internal NV-RAM to store the following items after the power has been turned off. Therefore, when the power is turned on again, the operation can begin with the same state as when the power was turned off.

- Display items in drive mode
- Frequency command from the digital operator
- The sequence of failure items that occurred before the power was turned off (including the content of CPF failure).

# 9. TROUBLESHOOTING

If the VS-616GII malfunctions, find the cause and take the corrective action by following the flowcharts given in this section.

If the cause cannot still be located by the flowcharts, the inverter or some parts are damaged, or any other problem occurs, contact Yaskawa representative.

## 9.1 TROUBLESHOOTING FOR MOTOR SYMPTOM

(1) Motor will not run.

For operation from external command through external terminals (Digital or Analog operator not used.)

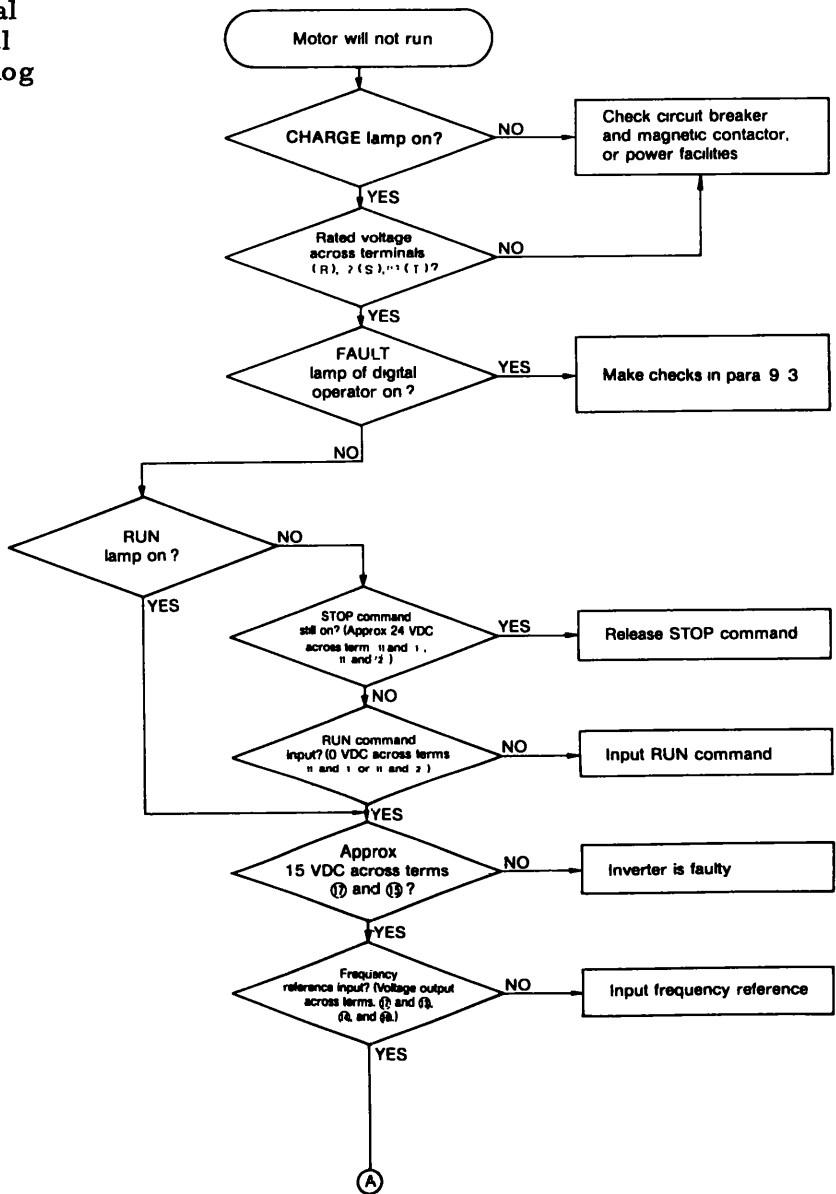
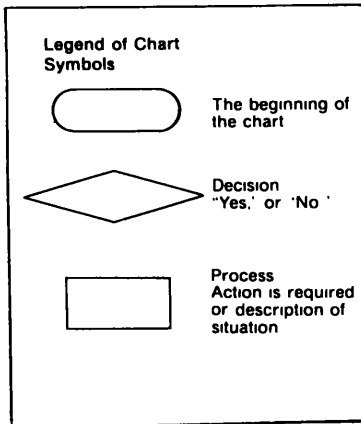

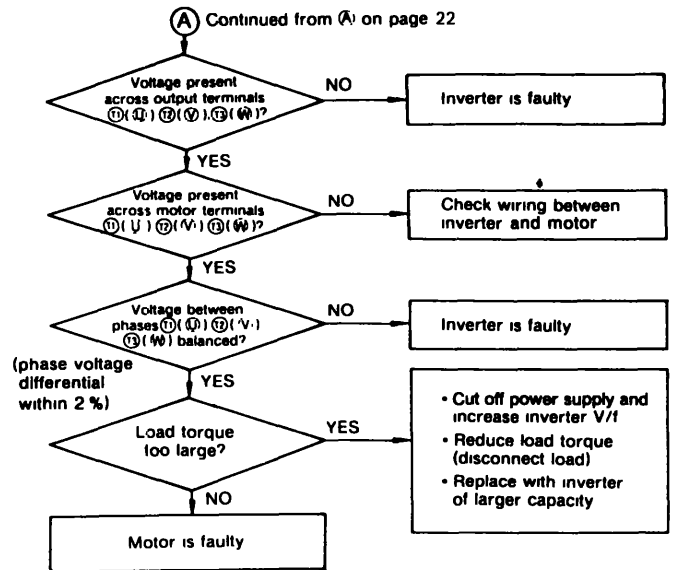

(2) Motor stalls during acceleration

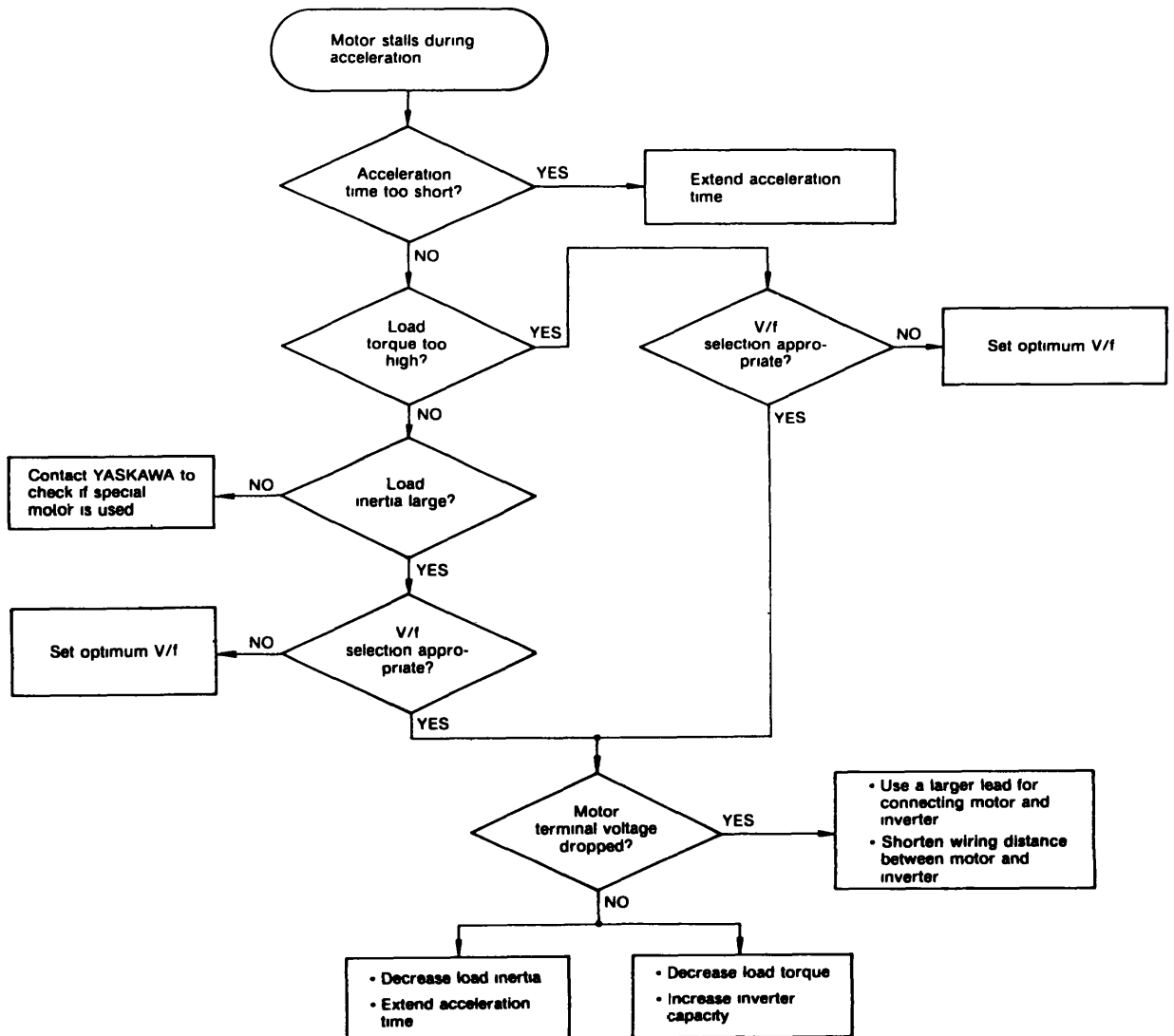

# APPENDIX 1 STANDARD SPECIFICATIONS

Table 8 Standard Specifications

Inverter Model CIMR-□□		380 to 460 V						
		H18.5G2	H22G2	H30G2	H37G2	H45G2		
Output Characteristics	Inverter Capacity	KVA	34	41	54	68	82	
	Rated Output Current	A	45	54	72	90	108	
	Over Load Current for one minute	A	56	68	90	113	135	
	Max Applicable Motor Output kW (HP)*	Overload Capacity 125% for one minute		22 (30)	30 (40)	37 (50)	45 (60)	55 (75)
		Overload Capacity 150% for one minute		18.5 (25)	22 (30)	30 (40)	37 (50)	45 (60)
	Max Output Voltage		3-Phase, 380/400/415/440/460 V (Proportional to input voltage)					
Rated Output Frequency		50, 60, 72, 90, 120, 180 Hz (up to 400Hz available)						
Power Supply	Rated Input Voltage and Frequency	3-Phase 380/400/415/440/460 V 50/60 Hz						
	Allowable Voltage Fluctuation	±10 %						
	Allowable Frequency Fluctuation	±5 %						
Control Characteristics	Control Method	Sine wave PWM						
	Frequency Control Range	0.1 to 400 Hz						
	Frequency Accuracy	Digital command 0.01 % (−10 to 40°C / +14 to 104°F) Analog command 0.1 % (25 ±10°C / 77 ±18°F)						
	Frequency Resolution	Digital operator reference 0.1 Hz, Analog reference 0.06 Hz/60 Hz						
	Output Frequency Resolution	0.01 Hz						
	Overload Capacity	125% for one minute or 150% for one minute (Load rate for max applicable motor)						
	Frequency Setting Signal	0 to 10 VDC (20 KΩ) 4-20 mA (250 Ω)						
	Accel/Decel Time	0.1 to 1800 sec (Accel/Decel time setting independently)						
	Braking Torque	Approx 20 %						
Protective Functions	Motor Overload Protection	Electric thermal overload relay						
	Instantaneous Overcurrent	Motor coasts to a stop at approx 200 % rated current						
	Fuse Blown Protection	Motor coasts to a stop by blown-fuse						
	Overload	Motor coasts to a stop at 125 % load for 1 minute						
	Overvoltage	Motor coasts to a stop if converter output voltage exceeds 790 V						
	Undervoltage	Motor coasts to a stop if converter output voltage drops to 420 V or below						
	Momentary Power Loss	Immediately stop by 15 ms and above momentary power loss. (Continuous system operation during power loss less than 0.2 sec) †						
	Fin Overheat	Thermostat						
	Stall Prevention	Stall prevention at acceleration /deceleration and constant speed operation						
	Ground Fault	Provided by electronic circuit						
	Power Charge Indication	Charge lamp stays ON until bus voltage drops below 50 V						
	Environmental Conditions	Location	Indoor (protected from corrosive gases and dust)					
Ambient Temperature		+14 to 104°F −10 to +40°C (not frozen)						
Storage Temperature †		−4 to 140°F −20 to +60°C						
Humidity		90 % RH (no condensation)						
Vibration		1 G less than 20 Hz, up to 0.2 G at 20 to 50 Hz						

\* Our standard 4-pole motor is used for Max Applicable Motor Output

† For 380 to 460 V, ride-through function up to 2 sec momentary power loss available by connecting backup capacitor 2200 μF 400 V between external terminals (C1) and (C2)

† Temperature during shipping. Storing in this temperature for a long-period may deteriorate main circuit capacitor contact, your Yaskawa representative



## APPENDIX 2 TERMINAL FUNCTIONS

### A2-1 Terminals of Main Circuit

Table 9 Terminal Functions and Voltages of Main Circuit

Terminals	Functions	Levels
		Model CIMR-H18.5B to -H75B
L1 (R)	Main circuit input power supply	3-phase 380/400/415/440/460 VAC at 50/60Hz (Voltage fluctuation $\pm 10\%$ )
L2 (S)		
L3 (T)		
g1 (r)	Control circuit input power supply	—
g2 (s)		
T1 (U)	VS-616GI output	3-phase 380/400/415/440/460 VAC (corresponding to input voltage)
T2 (V)		
T3 (W)		
$\oplus \ominus$	Braking unit	Approx 600 VDC
C <sub>1</sub> , C <sub>2</sub>	Backup capacitor for momentary power loss	Approx 300 VDC
G (E)	Ground terminal	—

### A2-2 Terminals of Control Circuit

Table 10 Terminal Functions and Signals of Control Circuit

Terminals	Functions	Levels
1	Forward operation-stop signal	Run at closed, stop at open
2	Reverse operation-stop signal	Run at closed, stop at open
3	External fault input	Fault at closed
4	Fault reset input (external)	Fault reset at closed
5	Following sequence control commands available to select 5-step speed setting, Master/Aux selector, Master/Aux selector at forward run, Mastet/Aux selector at reverse run, Energy saving operation, Override, External coasting stop command, Forward inching operation, Reverse inching operation, Coasting stop command, Speed search from top speed, Speed search from setting value, Accel/decel time selection	
6		
7		
8		
9	One of the following signals available to select During running, Zero speed Synchronized speed, Over-torque, Under voltage (NO)	Contact capacity 250 VAC at 1 A or below 30 VDC at 1 A or below
10		
11	Sequence control input common terminal	Sequence control input 0 V
12	Connection to shield sheath of signal lead	—
13	Master speed frequency reference input	0 to +10 V (20 k $\Omega$ )
14		4–20 mA (250 $\Omega$ )
15	Aux frequency reference input	+15V(Control power supply for frequency setting max 20 mA)
16		0 to +10 V/100 % (20 k $\Omega$ )
17		0 V
18	Fault contact output (NONC)	Common
19		Open at fault
20		Closed at fault
		Contact capacity 250 VAC at 1 A or below 30 VDC at 1 A or below

(1) Terminals ①, ② (Forward run command, reverse run command)

Status signals shown in Table 11.

Table 11 Forward/Reverse run command

Forward run command	Reverse run command	Description
Open	Open	Deceleration and stop (Stop indication is delayed 100 ms)
Closed	Open	Forward run
Open	Closed	Reverse run
Closed	Closed	The digital operator flashes Eb and when both are closed for 500 ms or more, it decelerates and stops the motor (not stored internally)

Note: Time chart at forward run is shown in Fig. 9.

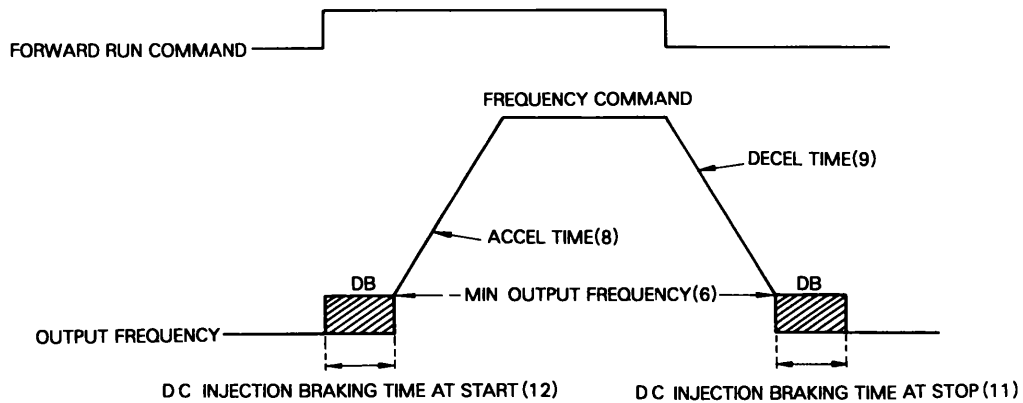

Fig. 9 Time chart at forward run

Note: Parenthesized values indicate the number of control constant. (See page 15.)

(2) Terminal ③ (external fault input)

When an external fault is input, the inverter coasts to a stop and the digital operator indicates Eb. Data is stored in the inverter until a fault reset is input.

(3) Terminal ④ (reset fault)

Used to reset fault. This is effective when both forward and reverse command are open.

(4) Terminals ⑤, ⑥, ⑦, and ⑧ (sequence functional terminals)

The function of terminal ⑤ is selected by the value set to system constant 8. Similarly, the function of terminal ⑥ is selected by the value set to system constant 9; the function of terminal ⑦ by the value set to system constant 10; the function of terminal ⑧ by the value set to system constant 11. (See Par. A4.7 Terminal Function).

(5) Terminals ⑨ - ⑩ (multifunctional contact output)

The output items from terminals ⑨ - ⑩ are selected by constant 12. (See Par A4-8 Contact Output Selection Function)

Contact capacity: 250 VAC, 1 A or less  
30 VDC, 1 A or less

(6) Terminals ⑬ and ⑭ (main speed frequency command)

Used to connect the master speed frequency command. When the master speed frequency command is set with a voltage, connect terminal ⑬ ; when set with a current, connect terminal ⑭ .

(7) Terminal ⑯ (auxiliary frequency command)

Used to connect auxiliary frequency command. The function may differ depending on the values set to system constants 8 and 9.

(8) Terminals ⑱ - ⑲ - ⑳ (fault contact output)

When a fault occurs, terminals ⑱ - ⑲ close and terminals ⑲ - ⑳ open.

Contact capacity: 250 VAC, 1 A or less  
30 VDC, 1 A or less

# APPENDIX 3 INTERNAL CIRCUIT AND INTERCONNECTION DIAGRAMS

## A3-1 With Braking Unit and Braking Resistor Unit

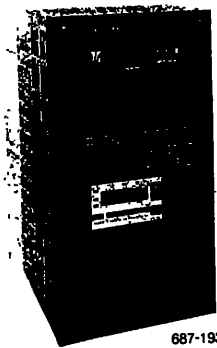
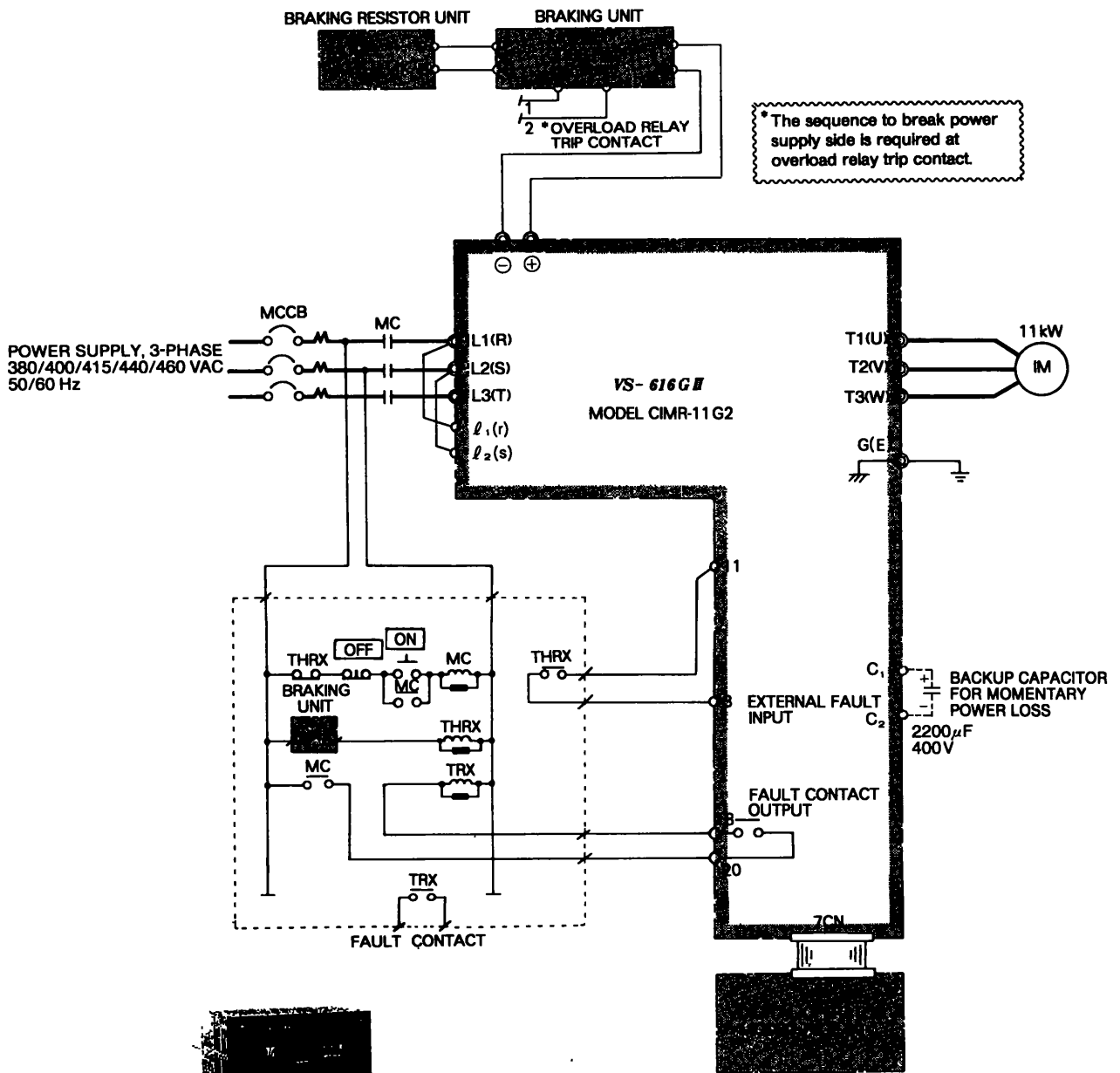

687-193

VS-616GII

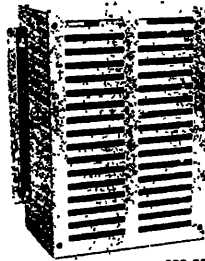

683-68

BRAKING RESISTOR UNIT

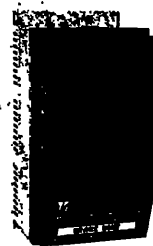

683-59

BRAKING UNIT

## A3-2 With Transistor (Open-Collector) For Start/Stop Operation

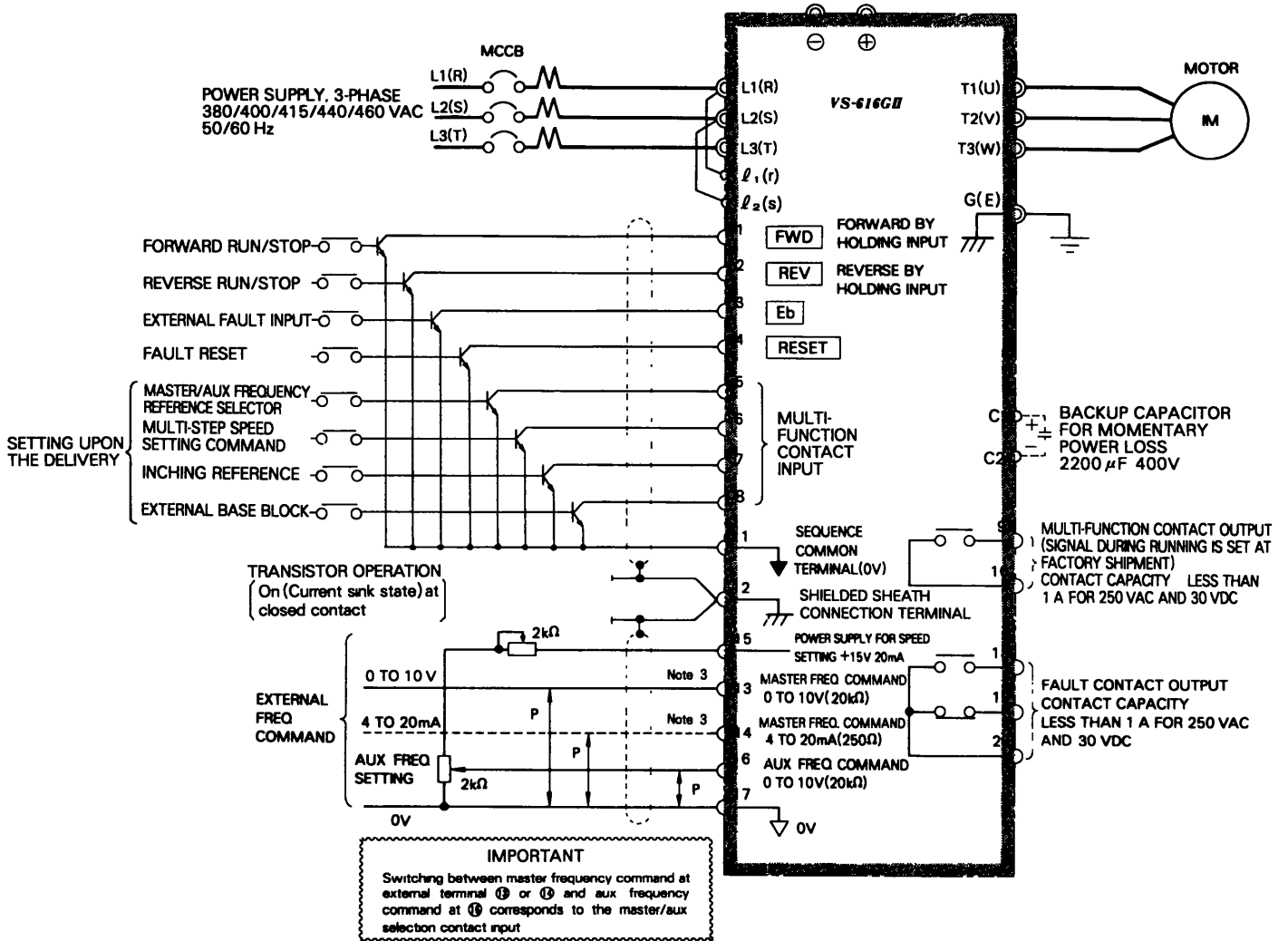

### Notes:

- ① indicates shielded leads and ② twisted-pair shielded leads.
- External terminal ⑤ of +15V has maximum output current capacity of 20mA.
- Either external terminal ③ or ④ can be used.
- Terminal symbols: ⊕ shows main circuit; ○ shows control circuit.

## APPENDIX 4 SYSTEM CONSTANTS

### A4-1 Inverter Capacity Selection (Sn-01)

As Table 12 shows, the inverter capacity has been set already. To use a spare printed circuit board, set the desired capacity.

Table 12 Inverter Capacity Selection

Sn-01 Data	Model (CIMR- <input type="text"/> )	Max Applicable Motor Output kW(HP)	Inverter Rated Current A	Motor Rated Current A (Factory setting)	Reference Current for Constant Setting* A
18	H18.5G2	18.5(25)	45	33.4	38
19	H22G2	22 (30)	54	38.5	45
1A	H30G2	30 (40)	72	52.3	60
1B	H37G2	37 (50)	90	65.3	75
1C	H45G2	45 (60)	108	78	90

\* The reference current for setting the overtorque detection level [Cn-23] and stall prevention during operation (On-18). (See page 51.)

Table 12.A Model and Code No. of Control PC Board

Inverter Model (CIMR- <input type="text"/> )	Control PC Board	
	Model	Code No.
H18.5G2	JPAC-C405- <input type="text"/>	ETC00938X-S <input type="text"/> XX
H22G2		
H30G2		
H37G2		
H45G2		

\*  indicates the contents of function. Use the PC board with same model or code No. as spare parts.

\* xx indicates the number of design change. Use the PC board with same number or more as spare parts.

## A4-2 Setting of V/f Pattern Selection (Sn-02)

The V/f pattern selector switch (Sn-02) has been factory-set at the notch ① for most applications. For specific applications such as fans and pumps, high-starting torques, or machine tools, select the optimum V/f pattern for motor running, according to the load characteristics. (See Table 13.)

IF Sn-02 is set to ⑥, arbitrary V/f pattern can be selected with control constants 1 to 7.

Table 13 V/f Pattern Selection (15 Patterns)

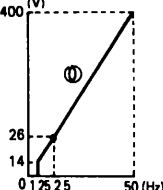
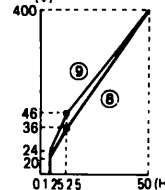
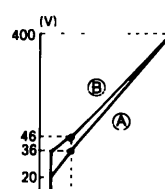
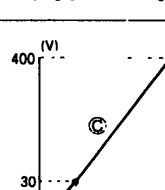
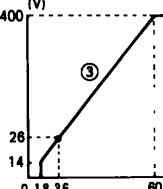
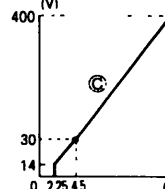
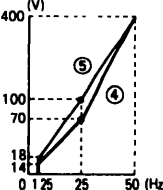
Application	Specification	Sn-02	V/f Pattern	Application	Specification	Sn-02	V/f Pattern		
General Purpose	50Hz	①		High Starting Torque	50Hz Starting Torque Low	⑧			
	60Hz	60Hz Saturation	① ⑥*		50Hz Starting Torque High	Starting Torque High	⑨		
		50Hz Saturation	②			50Hz Starting Torque Low	⑩		
	72Hz	③			Constant HP Operation (Machine Tools)	90Hz	③		
Variable Torque Operation (Fans and Pumps)	50Hz	Variable Torque 1	④	120Hz		④			
		Variable Torque 2	⑤						
	60Hz	Variable Torque 2	⑥					180Hz	⑤
		Variable Torque 1	⑦						

\* See APPENDIX 5 on page 42 to change V/f pattern

Notes 1 Take account of the following conditions and others when selecting V/f pattern

- Pattern matching the voltage-frequency characteristic of the motor
- According to the maximum motor speed

2 V/f pattern for high starting torque should be selected for

- Long wiring distance.
- Large voltage drop at start.
- AC reactor connected to input or output of the inverter.
- Use of motor of the rating below the max

For details, contact Yaskawa representative.

#### A4-3 Run Signal Selection (Sn-04)

The run command and frequency command that are validated by a combination of the 1st and 2nd digits differ (See Table 13).

(1) 1st digit (frequency command selection)

0: Runs by the frequency command from the external terminal.

1: Runs by the frequency command from the digital operator.

(2) 2nd digit (run command selection)

0: Runs by the run command from the external terminal.

1: Runs by the run command from the digital operator.

Table 13 Combination of Frequency and Run Commands

(○: effective ×: not effective)

Command	System Constant 4	Setting Value (1st and 2nd digits)			
		00	01	10	11
External Terminal	Forward run command	○	○	×	×
	Reverse run command	○	○	×	×
	External fault	○	○	○	○
	Fault reset	Note 2	Note 2	○	○
	Command of terminal ⑤	○	Note 1	×	×
	Command of terminal ⑥	○	Note 1	×	×
	Command of terminal ⑦	○	Note 1	×	×
	Command of terminal ⑧	○	Note 1	×	×
	Master freq command	○	×	○	×
	Aux input	○	×	×	×
	Fault contact output	○	○	○	○
	Contact of terminals ⑨-⑩	○	○	○	○
Operator	Freq. command	×	○	×	○
	Run key	×	×	○	○
	Jog key	×	×	○	○
	Stop key	Note 3	Note 3	○	○
	FWD/REV key	×	×	○	○
	△/RESET key	Note 2	Note 2	○	○
	DRIVE/PRG key	Effective during stop	Effective during stop	Effective during stop	Effective during stop
	REMOTE LED	ON	ON	OFF	OFF
	MONITOR indication	○	○	○	○

Note 1: Multi-step speed run, master speed/auxiliary switching, forward master speed/auxiliary switching, reverse master speed/auxiliary switching, override, and inching run commands are invalid.

2. Valid when the forward run command, reverse run command, and DB command are open.

3. When △ key and STOP/SET key are depressed at the same time, the motor decelerates and stops while STOP LED flashes. This stop command is stored in the inverter. Therefore, to resume operation, open both the forward run command and reverse run command of the external terminal.



(3) 3rd digit (master-speed frequency command)

Depending on the 3rd-digit value, the input method of the master-speed frequency command differs as shown in Fig. 10.

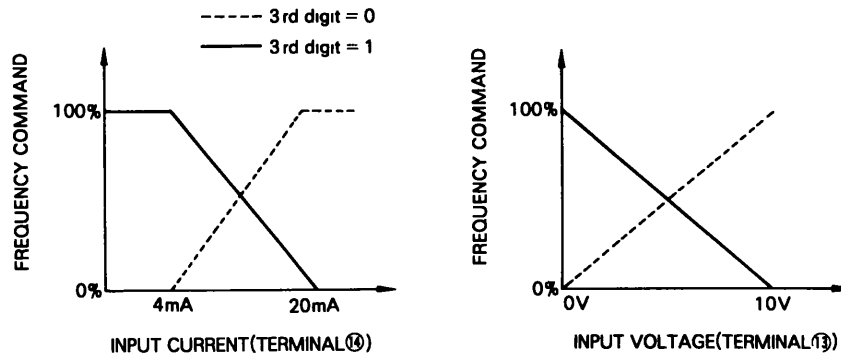

Fig. 10 Input method of Master Frequency Command

(4) 4th digit (reverse prohibit)

4th digit = 1: Disregards the reverse run command from the external terminal or digital operator.

A4-4 Protective Characteristics Selection (Sn-05)

(1) 1st digit (operation continues at momentary power failure)

1st digit = 0: A momentary power failure, when detected, is regarded as a fault in power supply and the operation stops after coasting.

1st digit = 1: When a momentary power failure is within 2 seconds, the operation continues; if longer than 2 seconds, the operation stops after coasting.

(2) 2nd digit (stall or no stall during deceleration)

2nd digit = 0: Stall during deceleration.

2nd digit = 1: No stall during deceleration.

(3) 3rd digit (motor protection)

3rd digit = 0: The electronic thermal protector protects the inverter and motor from overheat.

3rd digit = 1: The electronic thermal protector protects only the inverter from overload.

(4) 4th digit (motor selection)

4th digit = 0: Protection is made with the overload characteristics of the reduced-torque characteristic motor.

4th digit = 1: Protection is made with the overload characteristics of the constant-torque characteristic motor.

#### A4-5 Overtorque Detection (Sn-06)

##### (1) 1st digit

1st digit = 0: No overtorque is detected.

1st digit = 1: Overtorque is detected (different function from the stall during operation).

The overtorque detection function detects the following condition:

Inverter output current  $\geq$  overtorque detection level (control constant 23, set to 160% prior to shipment from the factory).

##### (2) 2nd digit

2nd digit = 0: Overtorque is detected during speed synchronization.

2nd digit = 1: Overtorque is always detected (except during stopping and DB).

##### (3) 3rd digit

3rd digit = 0: When overtorque is detected, the digital operator flashes OL3 and continues the operation.

3rd digit = 1: When overtorque is detected, the digital operator flashes OL3 and the operation stops after coasting (regarded as trouble and fault contact is output).

#### A4-6 Optional Function Selection (Sn-07)

##### (1) 1st and 2nd digits

Sets multiples of the output frequency that is output in the pulse monitor (JOGB-C01 type).

00: Outputs 6.F (F: output frequency)

01: Outputs 10.F (F: output frequency)

10: Outputs 12.F (F: output frequency)

11: Outputs 36.F (F: output frequency)

#### A4-7 Terminal Function (Sn-08 to Sn-11)

The function of terminal ⑤ is selected by the value set to system constant 8. Similarly, the function of terminal ⑥ is selected by the value set to system constant 9; the function of terminal ⑦ by the value set to system constant 10; the function of terminal ⑧ by the value set to system constant 11. Note each of these is independently selected.

When set values 0 to 3 are not set to system constants 8 to 11, the master-speed frequency command is applied for operation.

Table 15 Terminal Functions

Setting Value	Function	Description (0 : state signal) (1 pulse signal)
0	Master/Aux selector	Open 0 Master freq command Closed 0 Aux freq command
1	Master/Aux selector for forward run	When forward run command on, Open 0 Master freq command Closed 0 Aux freq command
2	Master/Aux selector for reverse run	When reverse run command on, Open 0 Master freq command Closed 0 Aux freq command
3	Multi-step speed setting	—
4	Override	Closed 0 Override
5	Inching operation	Closed 0 Inching freq selection
6	External coasting stop command	Closed 0 Coasting stop
7	Speed search	Closed 1 Speed search from top freq *
8	Speed search	Closed 1 Speed search from setting value.*
9	Energy saving operation	Closed 0 Energy saving operation
10	External fault	Open 0 Stops coasting and outputs failure contact
11	Operation mode selector (effective during stop)	Open 0 Operates in accordance with setting of 1st and 2nd digits of system constant 4 Closed 0 Operates in accordance with frequency command and operation command from the digital operator
12–17	Not used	—
18	Forward run/reverse run selector	When 18 is set to constant 11, operation is carried out in the sequence of run (terminal 1), stop (terminal 2), and forward run/reverse run selector (terminal 8) Open 0 Forward run. Closed 0 Reverse run
A	Accel/Decel time selector	Open 0 Accel/decel is executed by control constants 8 and 9 Closed 0 Accel/decel is executed by control constant 29
B	Inverter overheat prediction	OH2 blinks on digital operator
C	DC dynamic brake command	Closed 0 Dynamic brake activates if DC dynamic brake command is closed under the conditions of min output freq and below at deceleration stop
D	Not used.	
E		
F	No operation	Any signal inputs to the setting terminals not function

\*The search function of setting values 7 and 8 works even by pulse input signal of 20 ms and above.

#### Precautions for Combination of System Constants 8 to 11

When the following combination is set to system constants 8 to 11, this is regarded as a constant set value error (OPE), OPE is checked when power is supplied and when ENTRY is keyed in.

- (1) The set values are not placed in order from small to large. (Except for F, two or more values cannot be set.)
- (2) Both search commands of set values 7 and 8 are set.

(3) The forward master speed/auxiliary switching and the reverse master speed/auxiliary switching are not set in pairs.

(Set the forward master speed/auxiliary switching to constant 8 and the reverse master speed/auxiliary switching to constant 9.)

(4) Multispeed setup is set and master speed/auxiliary switching is not set.

(Set the master speed/auxiliary switching to constant 8 and the multispeed setup to constant 9.)

(5) Forward run/reverse run selection of setting value 18 is set to constant 8 to 10. (Set the forward run/reverse run selection to constant 11.)

(6) Override of setting value 4 is set to constant 9 to 11. (Set the override command to constant 8.)

#### A4-7-1 Description of Functions

##### (1) Master speed/auxiliary switching function

In both forward and reverse operations, this contact-input signal enables switching the master speed and auxiliary.

Open: The master speed frequency command is made the frequency command.

Close: The auxiliary frequency command is made the frequency command.

##### (2) The forward master speed/auxiliary switching and the reverse master speed/auxiliary switching functions

The main speed and auxiliary can be switched separately in forward and reverse operations. The forward master speed/auxiliary switching function and the reverse master speed/auxiliary switching function must be used in pairs.

Open: The master speed frequency command is made the frequency command

Close: The auxiliary frequency command is made the frequency command.

##### (3) Multispeed setup function.

The multispeed setup function must be used in a pair with the master speed/auxiliary switching function. A combination of these terminals makes the frequency command as shown in Table 16.

Table 16 4-step Speed Setting Method

Master/Aux Selector Command	Multi-step Speed Setting	Frequency Command
Open	Open	Master freq command
Closed	Open	Aux freq command
Open	Closed	Freq command 1* for multi-step speed setting
Closed	Closed	Freq command 2* for multi-step speed setting

\*Values set by control constants 27 and 28

(4) Override function

Open: The operation is made by the master speed frequency command (override cut).

Close: Override is carried out as shown in Fig. 11. The override gain is given by an auxiliary frequency command (0 to +10 V/0 to 200%).

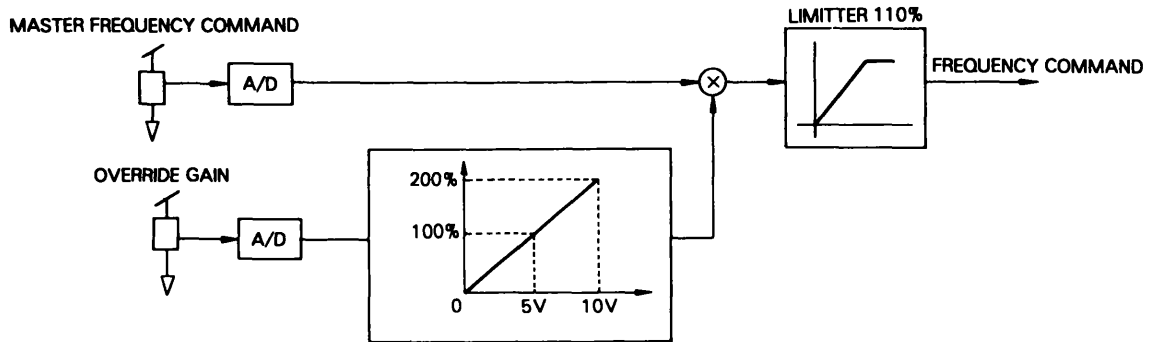

Fig. 11 Block Diagram of Override

(5) Inching function

Close: Only during close, the inching operation with control constant 26 (Setting to 6 Hz prior to shipment from the factory) as the frequency command is carried out. The rotating direction is given by the forward run command or reverse run command. The timing chart in forward and reverse operations are shown in Fig. 12.

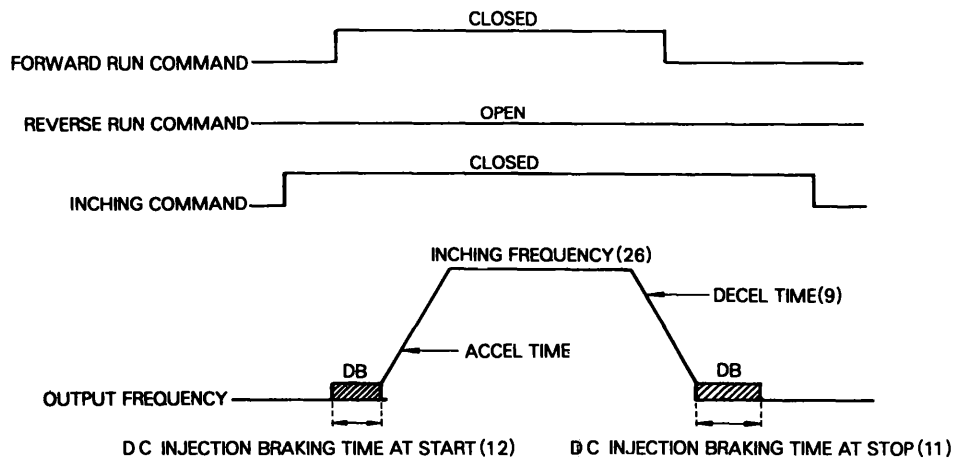

Fig. 12 Time chart at Forward and Inching Operations

Note: Parenthesized values indicate the number of control constant.

## A4-7-1 Description of Functions (Cont'd)

### (6) External coasting stop command function

When the external coasting stop command is closed, the operation depends on the input state of the forward run command and reverse run command.

- When either the forward run command or reverse run command is closed, and the external coasting stop command is also closed, only coasting stop is accomplished and the frequency is maintained.
- When both the forward run command and reverse run commands are open, and the external coasting stop command is closed, coasting stop is accomplished and the frequency is changed to 0 Hz.

### (7) Search function (rise detection)

When the search command is made to close, the base is blocked for 0.5 second, then the speed search is made. The operation depends on the selected function either 7 or 8. Note: functions 7 and 8 cannot be simultaneously selected.

- When 7 is set, the speed search begins with the highest set frequency.
- When 8 is set, the speed search begins with the frequency command that has been set after the search command was input.

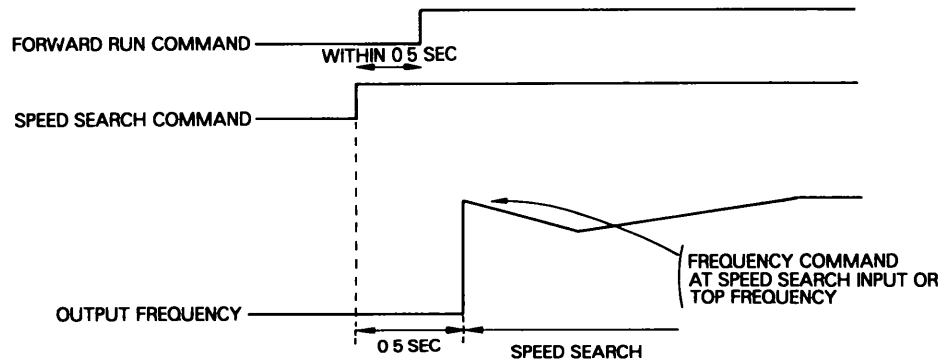

Fig. 13 Time chart at Speed search command Input

Note: When using this function by continuous operation mode at momentary stop, hold speed search command externally.

### (8) Energy-saving operation function

When the energy-saving operation command is made to close during speed synchronization, energy-saving operation shown in Fig. 14 is carried out. In the energy-saving operation, the output voltage is the value of the energy-saving gain (control constant 30, set to 80% at shipment from the factory) multiplied by the V/f constant set with control constants 1 to 7.

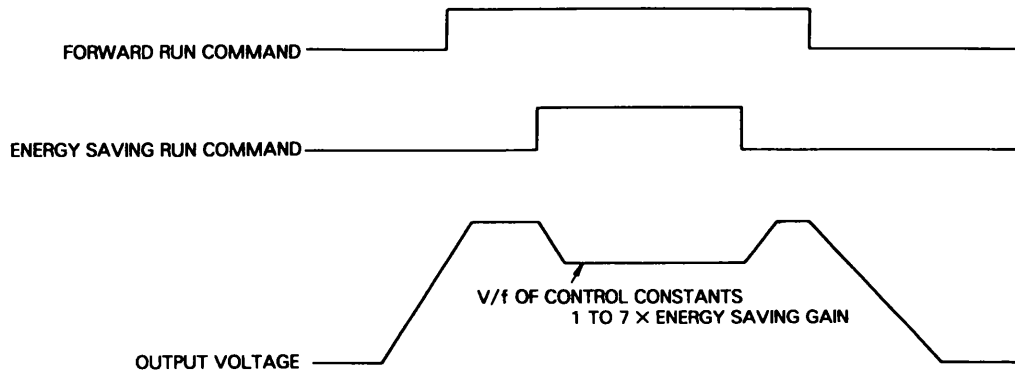

Fig. 14 Time Chart of Energy Saving Run

(9) Acceleration/deceleration time switching function

When the acceleration/deceleration time switching command is input, the acceleration/deceleration time changes. This function is also effective during inching operation.

Open: Operation made with accel/decel time of control constants 8 and 9.

Close: Operation made with acceleration/deceleration time of control constant 29.

(10) Inverter overheat prediction/display function

When the inverter overheat prediction/display command is input, the inverter flashes only OH2 on the digital operator's display. No other operation is carried out.

(11) DC injection braking(DB) function

When both the forward run command and reverse run command are open, and the DC injection braking command is closed, DC injection braking operation is carried out.

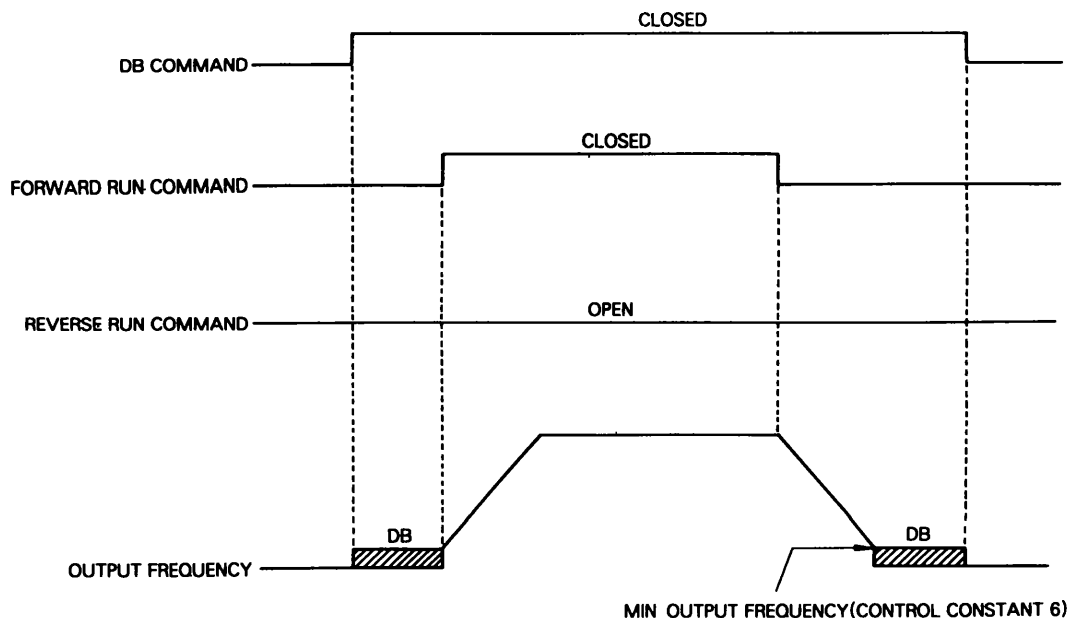

Fig. 15.1 Time Chart of DC Injection Braking

#### A4-7-1 Description of Function (Cont'd)

##### (12) External failure

Open: Operation stops with coasting and the digital operator indicates Eb. This condition is stored in the inverter until fault reset is input.

##### (13) Operation mode selection

When operation mode selection is input during stop, the operation mode changes.

Open: Operates in accordance with the setting of the 1st and the 2nd digits of system constant 4.

Closed: Operates in accordance with the frequency command and Run command from the digital operator.

(Operation corresponds to the following mode of system constant 4: 1st digit=1; 2nd digit=1)

(14) When 18 is set to system constant 11, operation is carried out in the 3-WIRE sequence of run (terminal 1), stop (terminal 2), and forward run/reverse run selector (terminal 8).

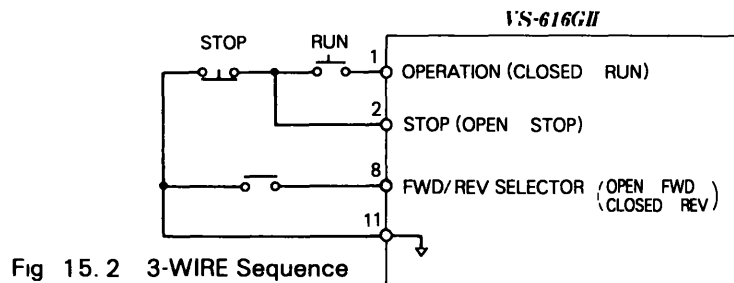

Fig 15.2 3-WIRE Sequence

#### A4-8 Contact Output Selection Function (Sn-12)

Set the content to be output through external terminals ⑨ - ⑩ to constant 12. Set the contents to be output through terminals ① to ④ (open collector output) of the output interface (model JOGB-C03) to constants ⑬ to ⑭, respectively. Table 17 shows the relationship between the set value of constant 12 and the content to be output.

Table 17 Contact Output Function

Setting Value	Description	
	Name	Signal Level (Closed)
0	Contact during run	Closed During run
1	Contact at zero speed	Closed Zero speed
2	Speed synchronized contact	Closed Speed synchronization
3	Overtorque detected contact	Closed Overtorque detection
4	Contact during UV	Closed During UV
5	Contact for speed-synchroization at any speed	Closed Output frequency = Cn-33
6	Output frequency detection contact	Closed Output frequency $\geq$ Cn-33
7	Output frequency detection contact	Closed Output frequency $\leq$ Cn33



(1) Contact during operation

The contact is closed when either the forward run command or the reverse run command is closed, or when the inverter is outputting a voltage.

(2) Zero-speed contact

The contact is closed when the inverter output frequency is 0Hz.

(3) Speed-synchronization contact

The contact is closed when either the forward run command or the reverse run command is closed, and the speeds are synchronized.

Speed-synchronization set condition:

$$|\text{Frequency command input} - \text{Output frequency}| \leq 0.5\%$$

Speed-synchronization reset condition:

$$|\text{Frequency command input} - \text{Output frequency}| \geq 3\%$$

(4) Overtorque detection contact

The contact is closed when the inverter detects an overtorque.

(5) During low voltage (UV) contact

The contact is closed while the inverter is measuring momentary power failure time when the mode is selected for operation to continue during momentary power failure. The contact is open when the inverter is stopping for a period exceeding the momentary power failure time-compensation period. Use this contact combined with the abnormality contact output.

(6) Contact for speed-synchronization at any set speed

The contact is closed when either the forward run command or the reverse run command is closed, and speed-synchronization occurs at the input frequency set by control constant 33.

Conditions of speed-synchronization setting and resetting are the same as stated in (3).

(7) Output frequency detection contact

The contact is closed when the output frequency is greater than the frequency set by control constant 33.

(8) Output frequency detection contact

The contact is closed when the output frequency is less than or equal to the frequency set by control constant 33.

## APPENDIX 5 CONTROL CONSTANTS

### (1) V/f constants (Cn-01 to Cn-07)

Sets V/f. Fig. 16 shows the relationship between constants 1 to 7.  $V_{MAX}$ '

$V_C$ , and  $V_{MIN}$  is standardized with the input voltage of 400V in 400-V system. Use the following formula to convert and set  $V_{MAX}$ ,  $V_C$ , and  $V_{MIN}$ .

$$V_{MAX} = V_{max} \times (400V)/V_{in}$$

$$V_C = V_c \times (400V)/V_{in}$$

$$V_{MIN} = V_{min} \times (400V)/V_{in}$$

[ $V_{max}$ ,  $V_c$ , and  $V_{min}$  are the actual output voltages;  $V_{in}$  is input voltage.]

To straighten V/f pattern

When  $F_B = F_{MIN}$  is set,  $V_C$  setup is invalidated and the output voltages of  $F_A$  to  $F_{MIN}$  become straight under the conditions of  $V_C \geq V_{MIN}$ .

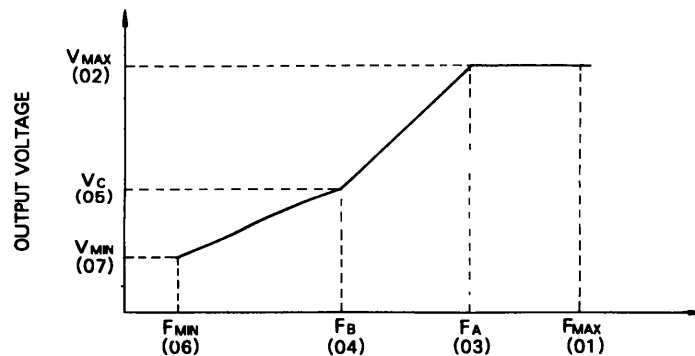

Fig. 16 V/f Characteristics by Control Constants 1 to 7

- Notes:
1. Parenthesized values indicate the number of control constant.
  2. Control constants 1 to 7 can be set only when system constant 2 is F.
  3. When constants not satisfying the condition  $F_{MAX} \geq F_A > F_B \geq F_{MIN}$  and  $V_{MAX} > V_C \geq V_{MIN}$  are set, an OPE (set value error) occurs. This is checked when power is supplied and when DSPL/ENTR is keyed in.

(2) Acceleration constants (Tacc) (Cn-08)

Sets the acceleration time during which the inverter output frequency reaches from 0% to 100%.

(3) Deceleration constants (Tdec) (Cn-09)

Sets the deceleration time during which the inverter output frequency changes from 100% to 0%.

(4) DC injection braking voltage (DBVOL) (Cn-10)

Sets the DC voltage that the inverter outputs at DC injection braking time in units of 0.1 V.

(5) DC injection braking time at stopping (DBTIM) (Cn-11)

Sets the braking time in units of 0.1 second during which DC injection braking is applied at stopping. When the DC injection braking time is 0, the operation stops after coasting, with the minimum output frequency (constant 6).

(6) DC injection time at starting (DBTWM) (Cn-12)

Sets the braking time in units of 0.1 second during which DC injection braking is applied at starting (by inputting a forward run command or reverse run command). When the DC injection braking time is 0, acceleration begins with the minimum output frequency.

(7) Frequency command gain (FGAIN) (Cn-13)

Sets the main-speed frequency command gain in units of 0.01. (See Fig. 17).

(8) Frequency command bias (FBIAS) (Cn-14)

Sets the main-speed frequency command bias in units of 0.1%, (See Fig. 17).

(9) Frequency command upper limit (FOUL) (Cn-15)

Sets the upper limit of the frequency command in ratio to the maximum frequency in units of 1%, (See Fig. 17).

(10) Frequency command lower limit (FOLL) (Cn-16)

Sets the lower limit of the frequency command in ratio to the maximum frequency in units of 1%. (See Fig. 17).

(11) Troublesome frequencies can be blocked by setting in Cn-17 to Cn-19 in units of 0.1 Hz. All frequencies  $\pm 1$  Hz of the blocked setting are not available for frequency commands. See page 51 for more frequency refinements.

APPENDIX 5 CONTROL CONSTANTS (Cont'd)

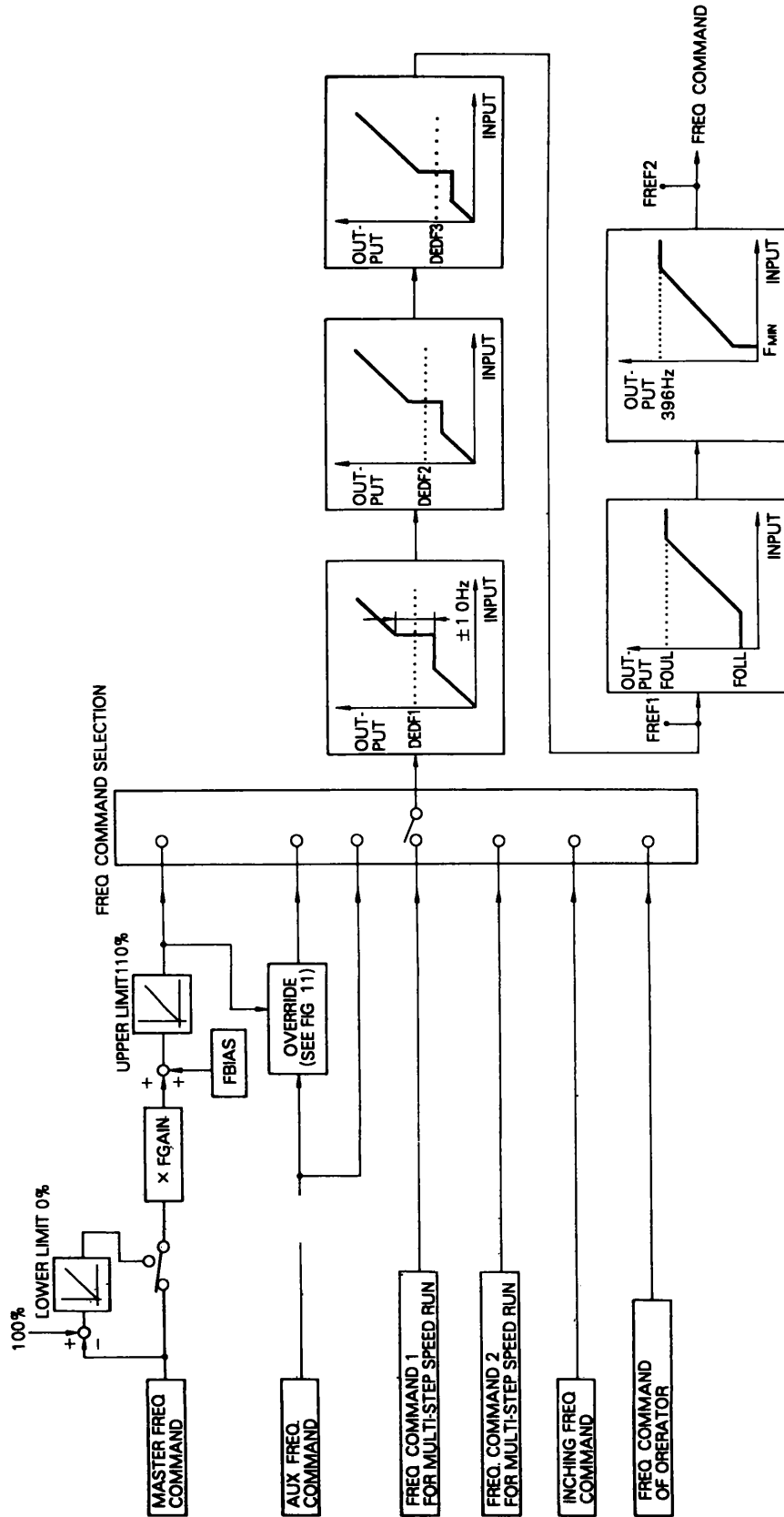

Fig. 17 Block Diagram of Frequency Command

(12) Motor rated current (Im100) (Cn-20)

Sets the motor rated current in units of 0.1A. (The motor rated current is used in the electronic thermal protector to protect the motor.) (See Table 11). Setting of reference current of 30% or below for constant setting shown in Table 5 is not effective and the current will be limited to 30%.

(13) Carrier frequency lower limit (CARRIER) (Cn-12)

Sets the lower limit of the inverter's carrier frequency in units of 1Hz. Although the carrier frequency depends on the output frequency and load, the minimum carrier frequency is set/here. Fig. 18 shows the relationship between the carrier frequency and the output frequency.

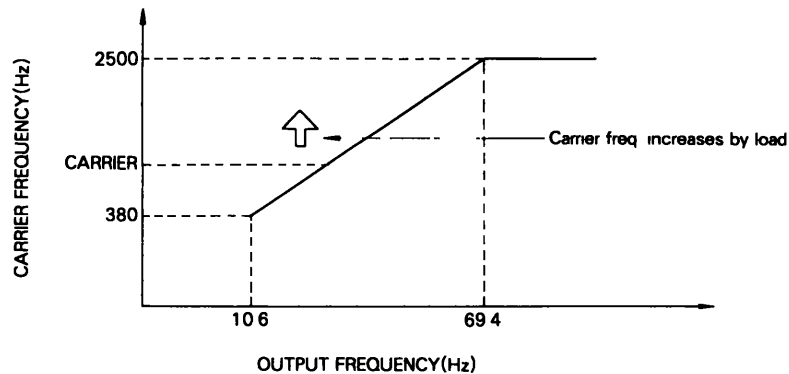

Fig. 18 Carrier Frequency and Output Frequency

(14) Torque compensation gain ( $K_T$ ) (Cn-22)

Sets the torque compensation gain in units of 0.1.

When the maximum applicable inverter motor has the same capacity as that of the motor actually used, this gain is 1. When a smaller motor is actually used, the gain is set to 1.0 or more.

(15) Overtorque detection level (Cn-23)

Sets the overtorque detection level in ratio to the reference current (See Table 11) for setting constants in units of 1%. Note the overtorque detection function differs from the stall during operation function.

(16) Frequency monitor gain ( $K_F$ ) (Cn-24)

Sets in units of 0.01 the gain of the frequency-meter output that the F-I monitor (JOGB-C02) outputs. (See Fig. 19).

## APPENDIX 5 CONTROL CONSTANTS (Cont'd)

### (17) Current monitor gain ( $K_I$ ) (Cn-25)

Sets in units of 0.01 the gain of the ammeter output that the F-I monitor (JOGB-C02) outputs. (See Fig. 19).

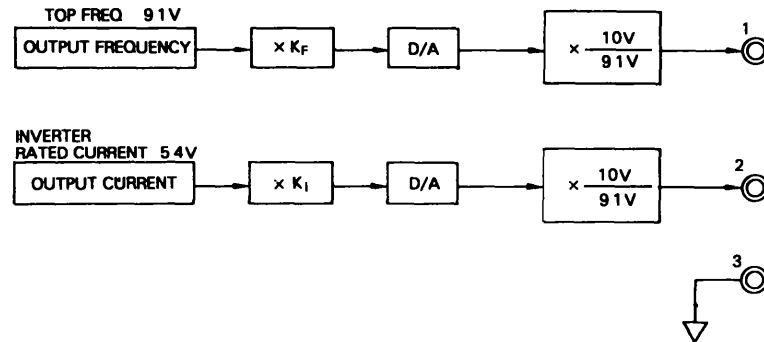

Fig. 19 Block Diagram of F-I Monitor

Calibrate the meter as follows:

In PRG mode, when control constant 24 is selected, the maximum frequency (about 10 V) is available at F-I monitor terminal 1; when control constant 25 is selected, the inverter rated current (about 6V) is available at F-I monitor terminal 2.

Maximum frequency: About 10V ① to ③

Inverter rated current: About 6V ② to ③

### (18) Inching frequency (NFJOG) (Cn-26)

Sets inching frequency in units of 0.1 Hz.

### (19) Multispeed-run-frequency commands 1 and 2 (FRKF1 and FREF2) (Cn-27 and Cn-28)

Sets multispeed-run-frequency commands in units of 0.1 Hz.

### (20) Acceleration/deceleration time (Cn-29)

Sets the acceleration/deceleration time in units of 0.1 second when the acceleration/deceleration time switching command is closed.

### (21) Energy-saving gain (KSENG) (Cn-30)

Sets in units of 1% the level to which the output voltage is controlled in the energy-saving operation.

In the energy-saving operation, the output voltage is given by ( $V/f$  set by control constants 1 to 7  $\times$  energy-saving gain). (See Fig. 20.)

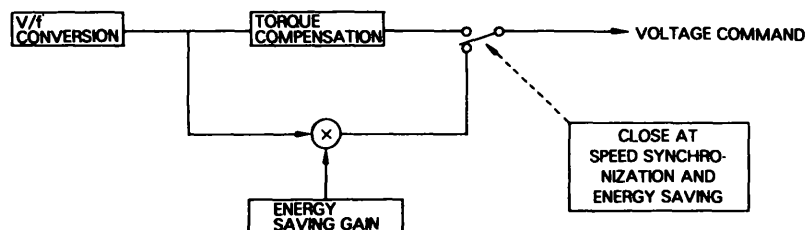

Fig. 20 Output Voltage During Energy-Saving Run

**(22) Slip compensation gain (Cn-31)**

Sets the slip compensation gain in units of 0.1. When the slip compensation gain is 1.0, the rated current of the inverter compensates 1% slip.

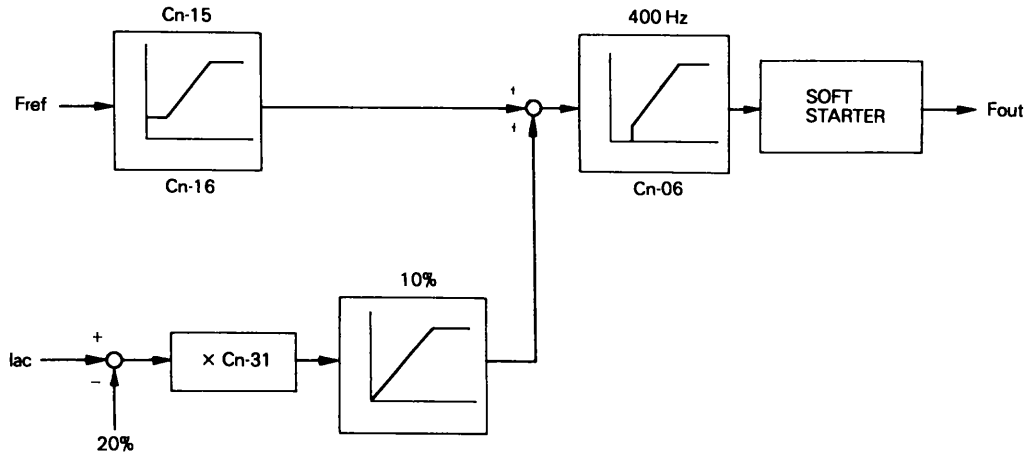

Fig. 21 Block Diagram of Slip Compensation

**(23) Frequency indication gain (Cn-32)**

Sets the gain for frequency indication. Depending on setting values the output frequency indication on the digital operator varies as shown in Table 18.

Table 18 Relation between Gain Setting and Frequency Indication

Setting Value	Output Frequency Indication
0	Indicates output frequency in units of 0.1 Hz
1 to 10	Setting value indicates the no. of poles of motor. Digital operator displays the motor synchronous rpm (output frequency $\times 120/Cn-32$ ). However the actual speed will decrease by the amount of slip reduction. Fractions are disregarded, and the indication for motor rpm over 9999 remains 9999.
11 to 39999	1st to 4th digits set a numeric to be indicated at 100% speed 5th digit Set the position of the decimal point. Set value 0 indicates 0000 Set value 1 indicates 000.0 Set value 2 indicates 00.00 Set value 3 indicates 0.000 (Example when Cn-32 = 10055 5.5 is indicated at 100% speed 2.2 is indicated at 40% speed)

**(24) Frequency for speed-synchronization at any set speed (Cn-33)**

Sets the frequency for speed-synchronization at any set speed in units of 0.1 Hz. Refer to Par. A4-8 Contact Output Selection Function for Signal Output.

## APPENDIX 6 OTHER CONSTANTS (FUNCTIONS)

### A6-1 Retry Operation at Fault

When fault occurs (FU, Eb, and CPF excluded) during operation, a retry operation can be carried out by automatically resetting the fault.

Automatic resetting can be tried up to 10 times. Fig. 22 shows the timing chart for retry operation in case of fault.

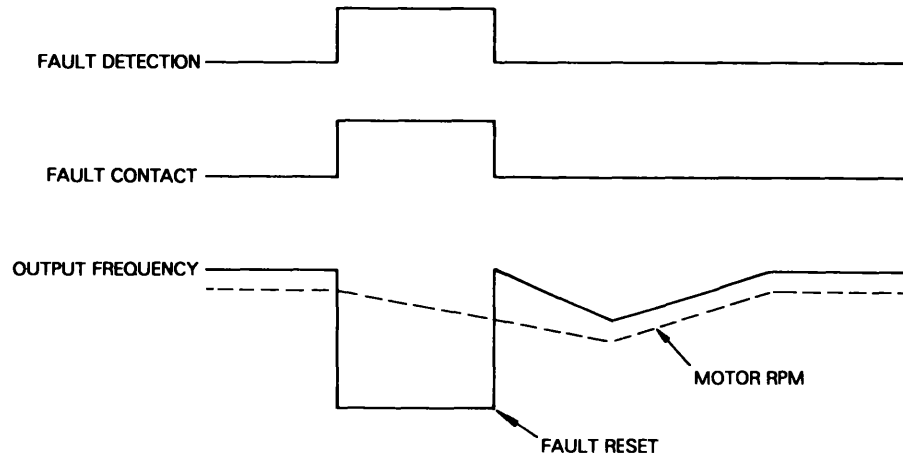

Fig. 22 Time Chart of Retry Operation at fault

The operation procedure for retry operation in case of fault is shown below.

- (1) Depress to select the program mode. [ Light off]
  - (2) Depress to select system constant .
  - (3) Select the numeric with and indicate (system constant 3).
  - (4) Depress to indicate the internal data of system constant 3.
  - (5) Set by operating and .
  - (6) Depress to temporarily store data.
  - (7) Indicate by operating and .
  - (8) Depress to indicate the internal data of .
  - (9) Set the number of times to reset faults by operating and .
- (When 5 times is set, it appears as .)
- (10) Depress to temporarily store data.
  - (11) Operate steps (2) to (6) to return the internal data of to .
  - (12) Depress to store data.
  - (13) After setting, depress to resume the drive mode. []



## A6-2 Full Range DC Injection Braking Stop(DB)

The use of the full range DC injection braking stop (DB) function permits a quick stop without using a braking resistor.

When a stop command is input, DC injection braking stop is carried out. The DB time at stop is set with control constant 11.

The time chart is shown in Fig. 23.

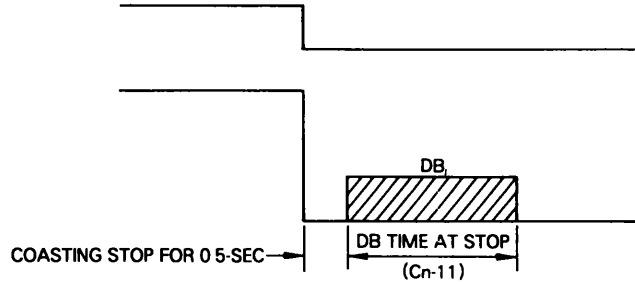

Fig. 23 Time Chart at DB Stop

The operation procedure for full range DC injection braking stop function is shown below.













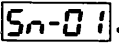

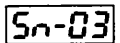

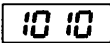



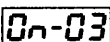

- (1) Depress to select the program mode. [ Light off]
- (2) Depress to select system constant .
- (3) Select the numeric with and indicate (system constant 3).
- (4) Depress to indicate the internal data of system constant 3.
- (5) Set by operating and .
- (6) Depress to temporarily store data.
- (7) Depress to indicate .
- (8) Depress to indicate the internal data of .
- (9) Indicate by operating and .
- (10) Depress to temporarily store data.
- (11) Operate steps (2) to (6) to return the internal data of to .
- (12) Depress to store data.
- (13) After setting, depress to resume the drive mode. [

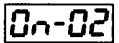
### A6-3 Range to Prohibit Frequency Setting

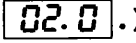
Frequency is not permitted to be set in a range usually within  $\pm 1$  Hz of the frequency set with constants 17 to 19. In this range, frequency command cannot be set (see page 44).

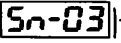
The value of this  $\pm 1$  Hz range where frequency setting is prohibited can be changed, in a range of 0.0 to 10.0 Hz, in units of 0.1 Hz.

The operation procedure for this purpose is shown below. Operation steps (1) to (6) and (11) to (13) are the same as in A6-1. So, steps (7) to (10) are shown.

- (1) Depress  to select the program mode. {  Light off }
  - (2) Depress  to select system constant .
  - (3) Select the numeric with  and indicate  (system constant 3).
  - (4) Depress  to indicate the internal data of system constant 3.
  - (5) Set  by operating  and .
  - (6) Depress  to temporarily store data.
  - (7) Indicate  by operating  and .
  - (8) Depress  to indicate the internal data of .
  - (9) Set the required range to prohibit frequency setting by operating  and .
- (When 2.0 Hz is set, it appears as .)
- (10) Depress  to temporarily store data.
  - (11) Operate steps (2) to (6) to return the internal data of  to .
  - (12) Depress  to store data.
  - (13) After setting, depress  to resume the drive mode. {  }















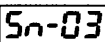

#### A6-4 Stall Prevention During Operation

During operation (while the speed is being synchronized), if the inverter output current exceeds the stall prevention during operation level (setting to 160% at shipment from the factory), the output frequency is dropped at a rate of half the predetermined deceleration time.

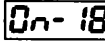



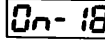

When the output current drops below the stall prevention during operation level, the output frequency is accelerated to the set value at the specified acceleration time.

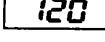
The stall prevention during operation level can be set, in units of 1%, in ratio to the reference current for setting constants. (See Table 11 on page 30).

The operation procedure to set or change the stall prevention during operation level is shown below. Operation steps (1) to (6) and (11) to (13) are the same as in par. A 6.1.

- (1) Depress  to select the program mode. [ Light off]
- (2) Depress  to select system constant .
- (3) Select the numeric with  and indicate  (system constant 3).
- (4) Depress  to indicate the internal data of system constant 3.
- (5) Set  by operating  and .
- (6) Depress  to temporarily store data.
- (7) Indicate  by operating ,  and .
- (8) Depress  to indicate the internal data of .
- (9) Set the stall level during run by operating  and .

(When 120% is set, it appears as .)

- (10) Depress  to temporarily store data.
- (11) Operate steps (2) to (6) to return the internal data of  to .
- (12) Depress  to store data.
- (13) After setting, depress  to resume the drive mode. [

To remove the function to prevent stall during operation

To remove the function to prevent stall during operation, set the stall prevention during operation level to 200%.

### A6-5 Multispeed Setting Method (5-speed operation by internal constants)

All-digital 5-speed operation is possible as shown below by the use of combinations of SW1 to SW3.

Moreover, any multistep (2-to 5-step) operation is possible by applying this sequence to set internal constants.

In this case, the analog frequency command (voltage/current) need not be input to the master/aux frequency command terminals.

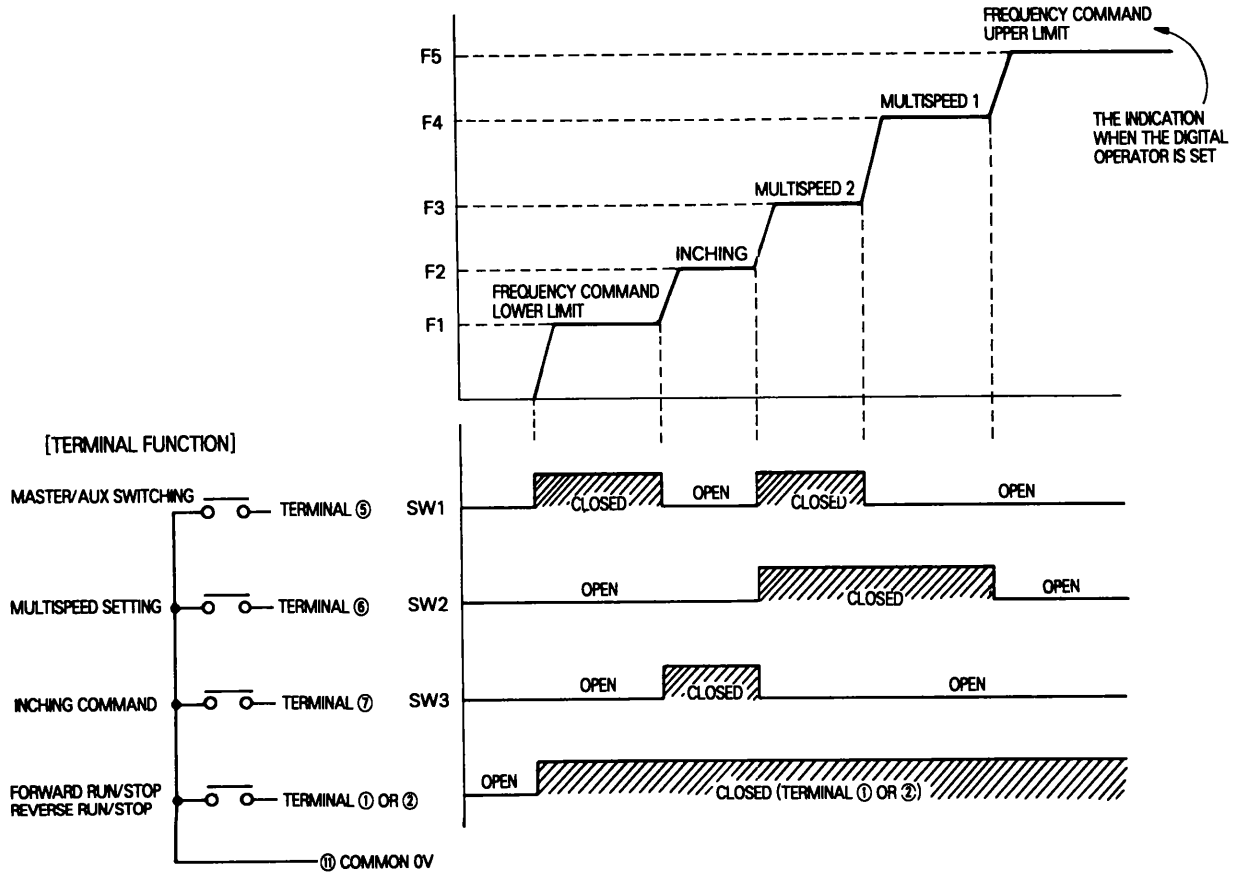



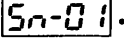

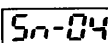









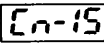



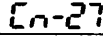
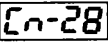
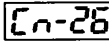
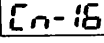





Fig. 24 Multispeed Setting Method

- (1) Depress  to select the program mode. [  blinking stops ]
- (2) Depress  to select the system constant .
- (3) Select the numeric with  and indicate  (system constant 4).
- (4) Depress  to indicate the internal data of system constant 4.
- (5) Set  by operating  and .
- (6) Depress  to temporarily store data.
- (7) Indicate  by operating  and .
- (8) Depress  to indicate the internal data of .
- (9) Set output frequency (F5) in \*percentage of the highest frequency (Cn-01) by operating  and .
- (10) Depress  to temporarily store data.
- (11) Operate steps (7) to (10) to set output frequencies (F4, F3, F2) to , , and  in units of 1 Hz, respectively.
- (12) Operate steps (7) to (10) to set output frequency F1 to  in units of 1%.
- (13) Finally depress  to store data.
- (14) After completing all the steps, depress  to return to the drive mode. [  blinks ]

## APPENDIX 7 OPTION

Name	Model (Code No.)	Mounting Place	Specifications			
			Terminal Symbol	Function	Level	Output Accuracy
Pulse Monitor	JOGB-C01 (73616-0051X)	Surface of the controller (Both monitors can not be mounted at the same time)	①-② (OV)	Pulse monitor (Inverter output frequency F)	Selection of 6·F, 10·F, 12·F, 36·F possible (V <sub>in</sub> 12V, I <sub>in</sub> 20mA) Duty 50% See Sn-07 of Par A4-6	0.03% (Sampling for 1 sec)
F-1 Monitor	JOGB-C02 (73616-0052X)		①-③ (OV)	Frequency monitor (Inverter output frequency)	Approx 10V/100% Output Impedance 200Ω	0.5%
			②-③ (OV)	Current monitor (Inverter output current)	Approx 10V/170% Output Impedance 200Ω	3%
Output Interface Card	JOGB-C03 (73616-0053X)		①-⑤ (OV)	4-contact output Select signals among during run, Zero speed, Agreed speed, Optional speed, Agreed frequency, Output frequency detection, Low voltage See Sn 13 to Sn-16	Open collector output (48VDC, 50mA and below)	
Input Interface Card	JOGB-C04 (73616-0054X)	①②③④⑤⑥⑦⑧⑨ (OV)	Digital speed input See Sn-07	Binary 8-bit BCD 2-digit	100%/255	
		⑩-⑪ (OV)	Frequency monitor (Inverter output frequency F)	Approx 10V/100% Output impedance 200Ω	0.5%	
		⑫-⑬ (OV)	Current monitor (Inverter output current F)	Approx 10V/170% Output impedance 200Ω	3%	

\*See Cn-24, 25 of Par.A5 for adjustment of F-1 monitor.  
Use BVDC, 1mA full scale of frequency meter and ammeter.

### INTERCONNECTION DIAGRAM WITH F-1 MONITOR

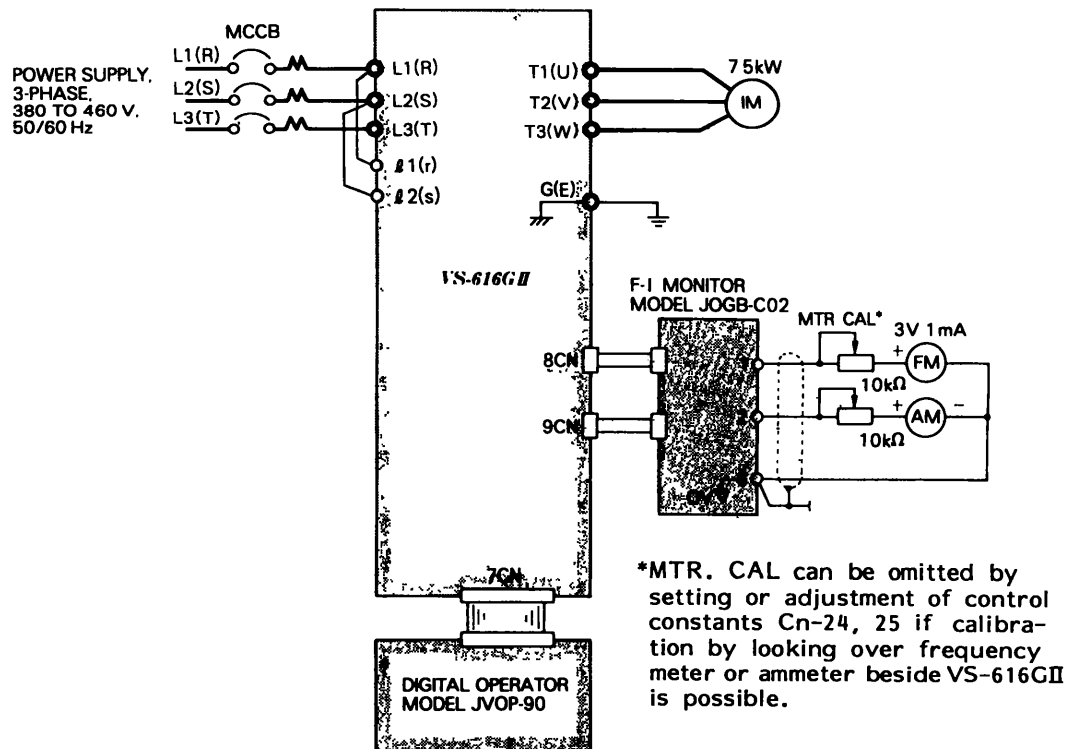

(1) Output system of the output interface

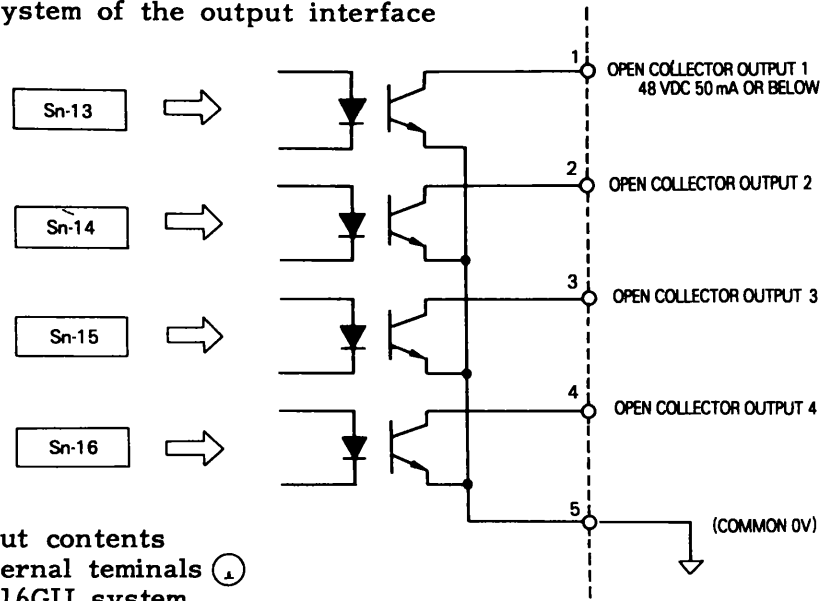

Set the output contents from the external terminals ① to ④ to VS-616GII system constants Sn-13 to Sn-16, respectively. (See Sn-13 to Sn-16 on page 40.)

(2) Input system of the input interface.

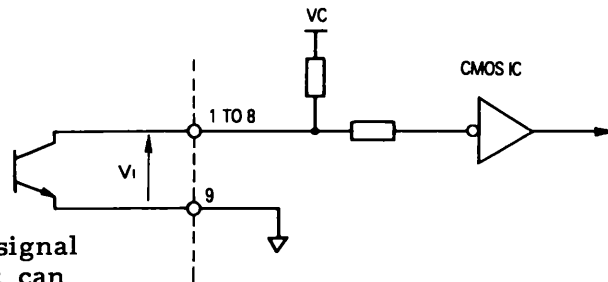

The input signal is 「0」 at open state, and is 「1」 at closed state (short-circuited with terminal number ⑨).

Input Voltage $V_i$ V	Signal Level
3.5 to 5.0	「0」
0 to 1.5	「1」

The digital signal input circuit can receive the output of the open collector.

Fig. 25 Equivalent Circuit of Digital Signal Input

Table 19 Input Signals of Input Interface

Terminal Number	Input Signal		Notes	
	Binary	BCD		
1	$2^0$	1	} $\times 10^0$	
2	$2^1$	2		
3	$2^2$	4		
4	$2^3$	8		
5	$2^4$	1		} $\times 10^1$
6	$2^5$	2		
7	$2^6$	4		
8	$2^7$	8		
9	(0V)	(0V)	Either 8-bit binary or 2-digit BCD input is selected by the 3rd and 4th digits of system constant Sn-07 (See Sn-07 on page 33)	

**OPTIONAL UNIT**

	Name	Model (Code No.)	Function	Mounting	Instruction Manual No.	Notes
Monitors and Operators	Digital Monitor	JVOP-91 (73041-0901X)	Frequency or current digital monitor displays and fault indications can be performed Run/Stop operation and constant settings are protected against tampering on site	Mounted on the front of inverter units	---	
	Remote Operator	JVOP-92-1 (73041-0902X-01)	The remote operators interconnected with the remote interface JVOP-94 are capable of Run/Stop operations, constant settings, and monitor displays with digital commands from remote locations (max 20m(65.6ft)) Operation procedures are the same as those of JVOP-90 (standard)	Separately-mounted (wall-mounted)	TOE-C736-20-3	Special cables are required
		JVOP-92-2 (73041-0902X-02)		Separately-mounted (flush-mounted)		
	Remote monitor	JVOP-93-1 (73041-0903X-01)	The remote monitor interconnected with the remote interface JVOP-94 are capable of digital monitor displays, and fault indications Run/Stop operations and constant settings are not available Operation procedures are the same as those of JVOP-91	Separately-mounted (wall-mounted)		
		JVOP-93-2 (73041-0903X-02)		Separately-mounted (flush-mounted)		
	Remote interface	JVOP-94 (73041-0904X)	Interface between remote operator (JVOP-92-1, 2) and remote monitor (JVOP-93-1, 2)	Mounted on the front of inverter units		
	VS Operator (Small Plastic Type)	JVOP-95-1 (73041-0905X-1)	The special operator JVOP-95 is capable of frequency settings and RUN/STOP operations with analog commands from remote locations (max 50m) F-I monitor card should be provided with VS-616GII for output frequency monitoring Frequency meter specifications 60/120 Hz 90/180 Hz	Separately-mounted		
VS Operator (Standard Steel Plate Type)	JVOP-96-1 (73041-0906X-1)	The special operator JVOP-95 is capable of frequency settings and RUN/STOP operations with analog commands from remote locations(max 50m) F-I monitor card should be provided with VS-616GII for output frequency monitoring Frequency meter specifications 75 Hz 150 Hz 220 Hz	Separately-mounted	TOE-C730-50-2		
Remote Operator Remote monitor Special Cable	(72616-WG003) (72616-WG005) (72616-WG016) (72616-WG020)	The special cables for connections between the remote operator or remote monitor and the remote interface Cable length 3m 5m, 10m, 20m(9.84ft 16.4ft 32.8ft 65.6ft)				
Others	Braking unit	CDBR-□□	For motor decel time reduction use this with braking resistor unit (For 200 V 20.6 to 27.4 kVA)	Separately-mounted	TOE-C730-40-6	
	Braking Resistor Unit	LKEB-□□	Motor regenerative energy dissipation by the resistor reduces the decel time	Separately-mounted	TOE-C730-40-4 TOE-C730-40-6	

Notes: 1 More than two-unit such as JVOP-91 and 94 installation at a time on the front cover of inverter is not allowed. And remove the existing digital operator JVOP-90 (Provided as standard).



## APPENDIX 8 CHECK FUNCTION

By selecting constants (CH-01 and CH-02) in PRG mode, both the digital operator LED and external terminals ① to ⑧ can be checked.

(1) CH-01 (Checks the digital operator LED)

Select CH-01 and depress RUN/DATA key. Then, all LEDs light.

(2) CH-02 (Checks external terminals ① to ⑧)

Select CH-02 and depress RUN/DATA key. Then, the state of external terminals ① to ⑧ appears.

Sample display when external terminals ①, ③, ⑤ and ⑥ are open and ②, ④, ⑦ and ⑧ are closed is shown below.

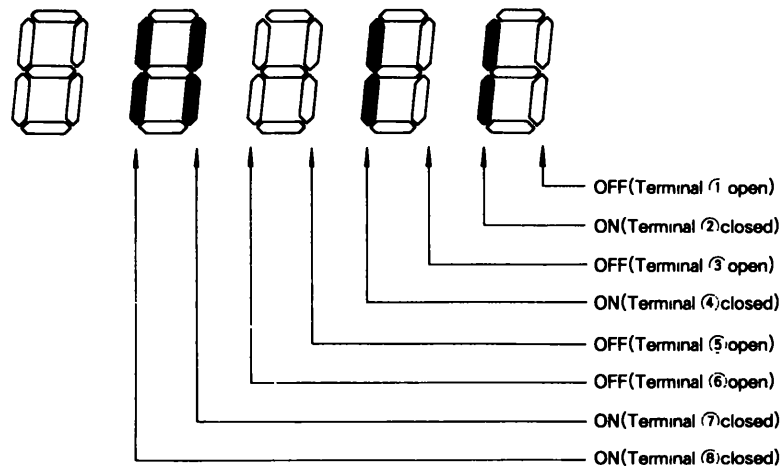

## APPENDIX 9 CHECKING OF DIODE AND TRANSISTOR MODULES

### A9-1 Diode Module

Measure the resistance across the module terminals with a volt-ohm meter. Use the meter by setting at  $\times 1\Omega$  range. The measured resistance should be within the reference value listed in Table 20.

Table 20 Diode Module Resistances

Diode Module Terminals	Volt-ohm Meter Terminals	$\ominus$	$\oplus$	Reference Resistances	Abnormal Resistances
Model CIMR-H18.5G2 TO -H45G2		②	①	$\infty$	Approx several 10 ohms
		①	③		
		①	②	Approx several 10 ohms	$\infty$ or $0\Omega$
		③	①		

### A9-2 Transistor Module

Measure the resistance across the module terminals with a volt-ohm meter. Use the meter by setting at  $\times 1\Omega$  range. The measured resistance should be within the reference value listed in Table 21.

Table 21 Transistor Module Resistances

Transistor Module Terminals	Tester Terminal	$\ominus$	$\oplus$	Reference Resistances	Abnormal Resistances
		$E_1 C_2$	$C_1$	Several ohms to several 10 ohms	$0\Omega$ or $\infty$
		$C_1$	$E_1 C_2$	$\infty$	$0\Omega$
		$B_1$	$E_1 C_2$	Several 10 ohms	Several 10 kilohms or above
		$E_1 C_2$	$B_1$	Several 10 ohms to several 100 ohms	$0\Omega$ or $\infty$
		$E_2$	$E_1 C_2$	Several ohms to several 10 ohms	$0\Omega$ or $\infty$
		$E_1 C_2$	$E_2$	$\infty$	$0\Omega$
		$B_2$	$E_2$	Several 10 ohms	Several 10 kilohms or above
		$E_2$	$B_2$	Several 10 ohms to several 100 ohms	$0\Omega$ or $\infty$
		$E$	$C$	Several ohms to several 10 ohms	$0\Omega$ or $\infty$
		$C$	$E$	$\infty$	$0\Omega$
		$B(B1)$	$E$	Several 10 ohms	Several kilohms
		$E$	$B(B1)$	Several 10 ohms to several 100 ohms	$0\Omega$ or $\infty$

Note Measure the resistance after conforming the discharge of smoothing capacitor

### CAUTION

When installing the diode module and transistor module, paint the Thermal Compound "JOINTAL Z" (manufactured by NIPPON KEIKINZOKU) on the mounting surface of modules. This increases the adhesion of mounting surface and cooling effect.

## APPENDIX 10 WIRE SIZE

Table 22 shows the wire sizes used for wiring, Table 23 shows the setup of round pressure terminals.

Table 22 Wire Size

Circuit	VS-616GII Model	Inverter Capacity kVA	Terminal Symbol	Terminal Screw	Wire Size*		Wire Type		
					mm <sup>2</sup>	AWG			
Main	CIMR-H18.5G2	34	① (R), ② (S), ③ (T) ④ (U), ⑤ (V), ⑥ (W) ⊖ ⊕	M6	8-14	8-6	Power cable: 600 V vinyl-† sheathed lead or equivalent.		
	CIMR-H22G2	41		M8	22-38	4-1			
	CIMR-H30G2	45							
	CIMR-H37G2	68							
	CIMR-H45G2	82							
	CIMR-H18.5G2	34	M4					2-5.5	14-10
	CIMR-H22G2	41							
	CIMR-H30G2	45							
	CIMR-H37G2	68							
	CIMR-H45G2	82	M3.5	1.25-2	16-14				
CIMR-H45G2	82								
Control	CIMR-H18.5G2	34	① (D), ② (S) ③ (C) ④ (C)	M4	0.5-2	20-14			
	CIMR-H22G2	41		M3.5	1.25-2	16-14			
	CIMR-H30G2	45							
	CIMR-H37G2	68							
	CIMR-H45G2	82							
	Common to all models		1 to 20	M3.5	0.5-2	20-14	Twisted shielded lead for instrumentation.		

\* Wire size should be determined considering voltage drop of leads

† Polyethylene-insulated vinyl-sheathed with shielding

Table 23 Round Pressure Terminals

Wire Size		Terminal Screw	Round Pressure Terminal
mm <sup>2</sup>	AWG		
0.5	20	M3.5 M4	1.25-3.5
0.75	18		1.25-4
1.25	16		
2	14	M3.5	2-3.5
		M4	2-4
3.5	12	M4	5.5-4
5.5	10	M4	5.5-4
8	8	M6	8-6
14	6	M6	14-6
22	4	M8	22-8
38	1	M8	38-8

## APPENDIX 11 RENEWAL PARTS

As insurance against costly downtime, it is strongly recommended that renewal parts to be kept on hand in accordance with the table below. When ordering renewal parts, please specify to Yaskawa Electric office or representative with: Parts Name, Parts Code No. and Quantity.

Table 24 Renewal Parts

VS-616 GII Model	Parts Name	Main Circuit Transistor	Main Circuit Diode	Main Circuit Fuse	Base Drive PC Board	Control PC Board	Cooling Fan
	Item						
CIMR-H18.5G2	Type	QM150DY-2H	160Q2G41	A70P-80	JPAC-C263	JPAC-C405-□□□	4715PS-22T-B30-B00
	Code	STR000212	SID000337	FU000768	ETC00792X	ETC00938X-S□□□XX	FAN000130
	Qty	3	3	1	1	1	1
CIMR-H22G2	Type	QM150DY-2H	160Q2G41	A70P-80	JPAC-C263	JPAC-C405-□□□	4715PS-22T-B30-B00
	Code	STR000212	SID000337	FU000768	ETC00792X	ETC00938X-S□□□XX	FAN000130
	Qty	3	3	1	1	1	1
CIMR-H30G2	Type	QM200HA-2H	160Q2G41	A70P-125	JPAC-C266	JPAC-C405-□□□	5915PC-22T-B30-B00
	Code	STR000149	SID000337	FU000784	ETC00795X	ETC00938X-S□□□XX	FAN000131
	Qty	6	6	1	1	1	1
CIMR-H37G2	Type	QM300HA-2H	160Q2G41	A70P-150	JPAC-C266	JPAC-C405-□□□	5915PC-22T-B30-B00
	Code	STR000150	SID000337	FU000770	ETC00795X	ETC00938X-S□□□XX	FAN000131
	Qty	6	6	1	1	1	1
CIMR-H45G2	Type	QM300HA-2H	160Q2G41	A70P-150	JPAC-C266	JPAC-C405-□□□	5915PC-22T-B30-B00
	Code	STR000150	SID000337	FU000770	ETC00795X	ETC00938X-S□□□XX	FAN000131
	Qty	6	6	1	1	1	1

\* of the control PC board type name shows the type of function  
 Renewal board should have the same type name suffix as that of the board in use  
 \*XX of Code No for the control PC board indicates the revision number of the control PC board  
 New board should have the same code suffix number or larger than that of the board being replaced

**MEMO**



A Better Tomorrow for Industry through Automation

## YASKAWA Electric Mfg. Co., Ltd.

**TOKYO OFFICE** Ohtemachi Bldg., 1-6-1 Ohtemachi, Chiyoda-ku, Tokyo, 100 Japan  
Phone (03) 284-9111, -9145 Telex YASKAWA J33530 Fax (03) 284-9034

**SEOUL OFFICE** Seoul Center Bldg., 91-1, So Kong-Dong, Chung-Ku, Seoul, Korea  
Phone (02) 776-7844 Fax (02) 753-2639

**SINGAPORE OFFICE** CPF Bldg., 79 Robinson Road No. 24-03, Singapore 0106  
Phone 2217530 Telex (87) 24890 YASKAWA RS Fax (65) 224-5854

**TAIPEI OFFICE** Union Commercial Bldg., 137, Nanking East Road, Sec. 2, Taipei, Taiwan  
Phone (02) 507-7065, -7732 Fax (02) 508-3837

### YASKAWA ELECTRIC AMERICA, INC.: SUBSIDIARY

**Chicago Office (Head Office)** 3180 MacArthur Blvd., Northbrook, Illinois 60062-1917, U.S.A.  
Phone (708) 291-2340, 291-2348 Telex (230) 270197 YSKW YSNC NBRK Fax (708) 498-2430, 480-9731

**Los Angeles Office** 7341 Lincoln Way, Garden Grove, California 92641, U. S. A.  
Phone (714) 894-5911 Telex (230) 678396 YASKAWAUS TSTN Fax (714) 894-3258

**New Jersey Office** 30 Two Bridges Road, Fairfield, New Jersey 07008, U. S. A.  
Phone (201) 575-5940 Fax (201) 575-5947

### YASKAWA ELECTRIC EUROPE GmbH: SUBSIDIARY

Niederhöchstädter Straße 71-73, W 6242 Kronberg-Oberhöchstädt, Germany  
Phone (06173) 640071, 640072, 640073 Telex 415680 YASE D Fax (06173) 68421

### YASKAWA ELETRICO DO BRASIL COMÉRCIO LTDA.: SUBSIDIARY

Av. Brig Faria Lima, 1664-cj. 721/724, Pinheiros, São Paulo-SP, Brasil CEP-01452  
Phone (011) 813-3633, 813-3694 Telex (011) 82869 YSKW BR Fax (011) 816-8796

